



FOCADO DA MASSAVI

LOTE: 001

VENDEDOR(ES): AGROPECUARIA SANTA LUCIA

QTD.: 1

MSVI 1996 - NELORE - MACHO - NASC.:29/04/2015 - IDADE: 36 MS - CINZA

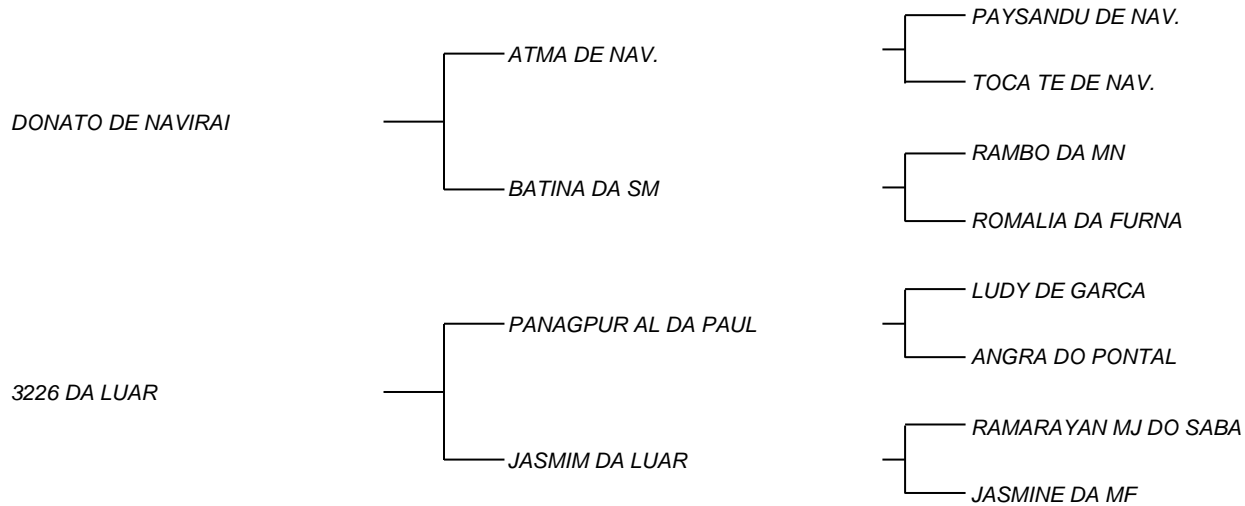

PESO: 886 KG. C.E.: 44 CM.

GENEAL DA MASSAVI

LOTE: 002

VENDEDOR(ES): AGROPECUARIA SANTA LUCIA

QTD.: 1

MSVI 2488 - NELORE - MACHO - NASC.:18/04/2016 - IDADE: 24 MS - CINZA

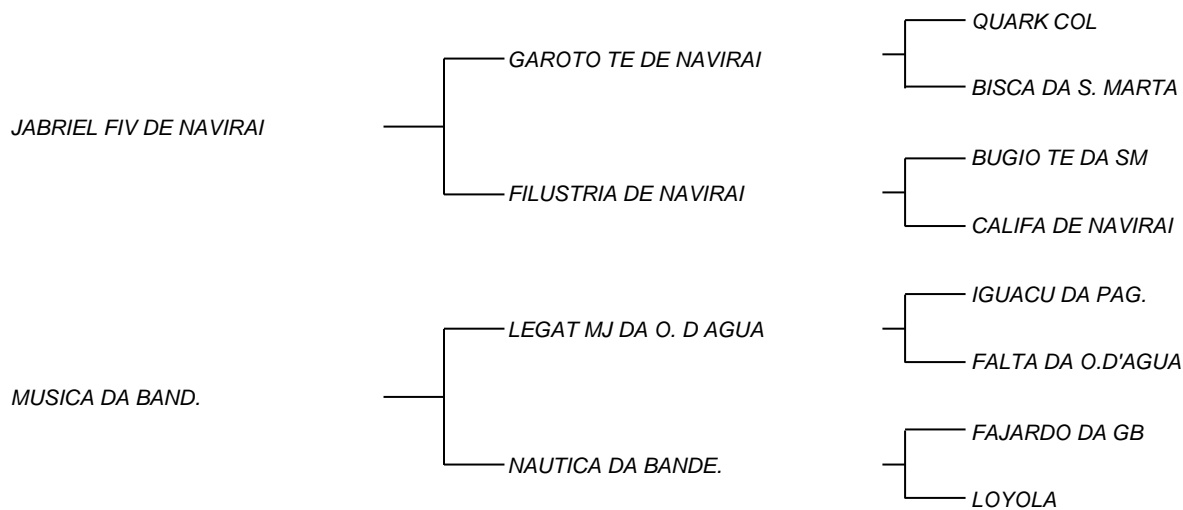

PESO: 660 KG. C.E.: 37 CM.



GORKO DA MASSAVI

VENDEDOR(ES): AGROPECUARIA SANTA LUCIA

LOTE: 003

QTD.: 1

MSVI 2533 - NELORE - MACHO - NASC.:15/05/2016 - IDADE: 23 MS - CINZA

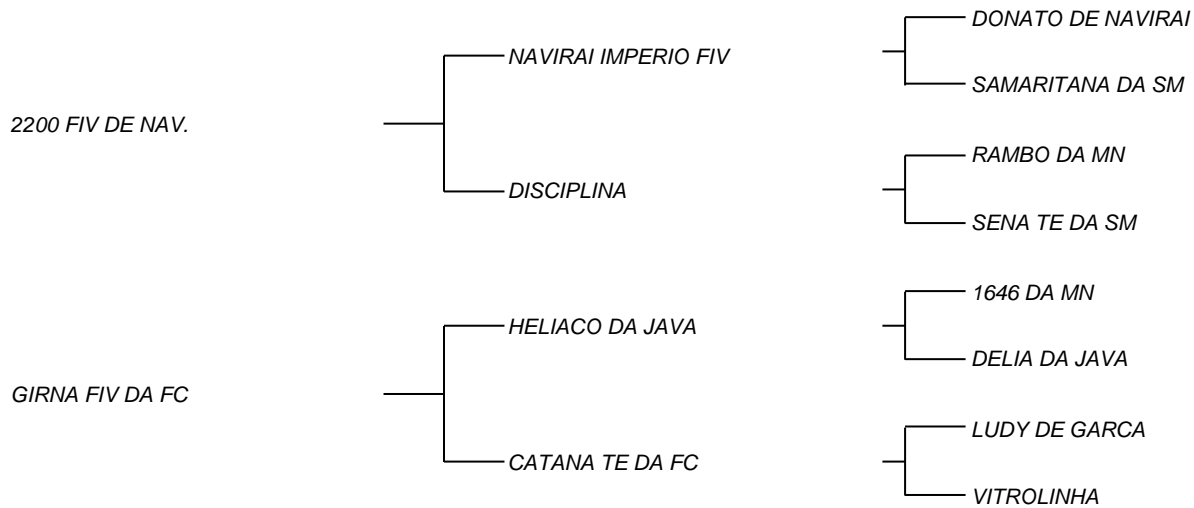

GANGSTER DA MASSAVI

VENDEDOR(ES): AGROPECUARIA SANTA LUCIA

LOTE: 004

QTD.: 1

MSVI 2435 - NELORE - MACHO - NASC.:26/03/2016 - IDADE: 25 MS - BRANCA

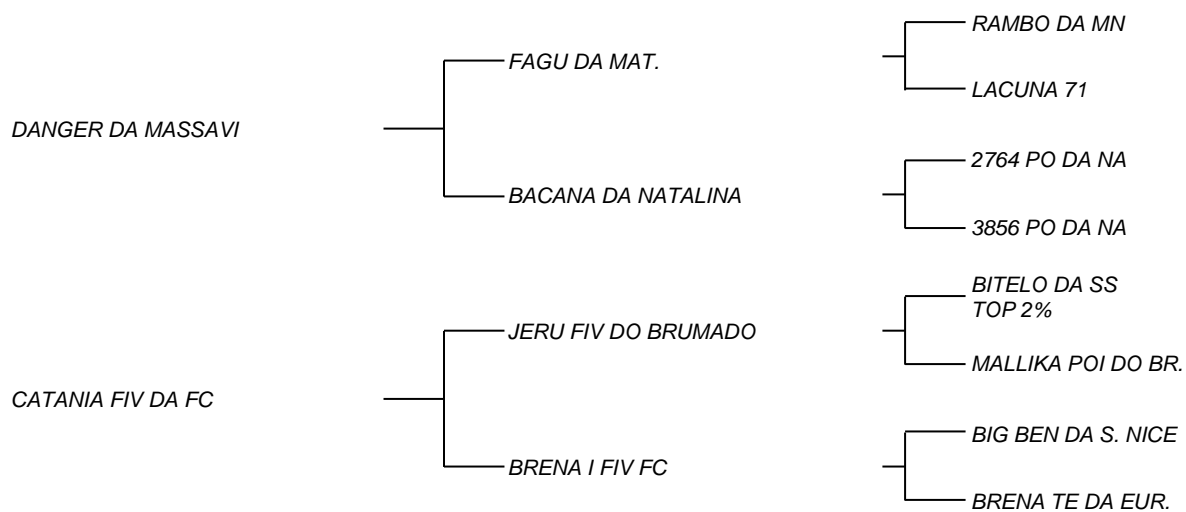



GODIN DA MASSAVI

LOTE: 005

VENDEDOR(ES): AGROPECUARIA SANTA LUCIA

QTD.: 1

MSVI 2451 - NELORE - MACHO - NASC.:07/04/2016 - IDADE: 25 MS - BRANCA

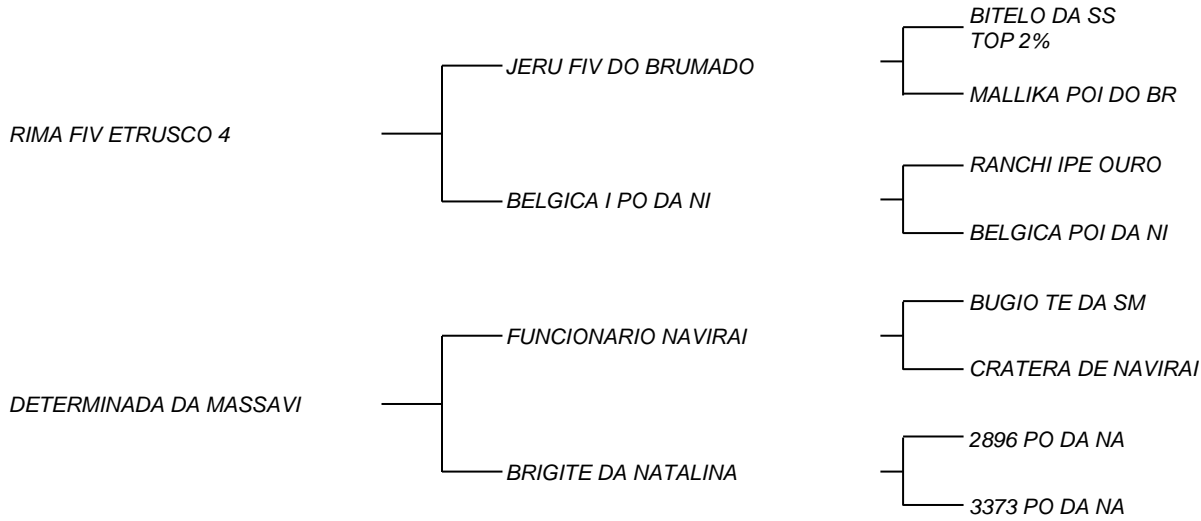

PESO: 601 KG. C.E.: 39 CM.

GURGEL DA MASSAVI

LOTE: 006

VENDEDOR(ES): AGROPECUARIA SANTA LUCIA

QTD.: 1

FAZENDA: AGROP. SANTA LUCIA/AGROPECUARIA SANTA LUCIA

MSVI 2513 - NELORE - MACHO - NASC.:30/04/2016 - IDADE: 24 MS

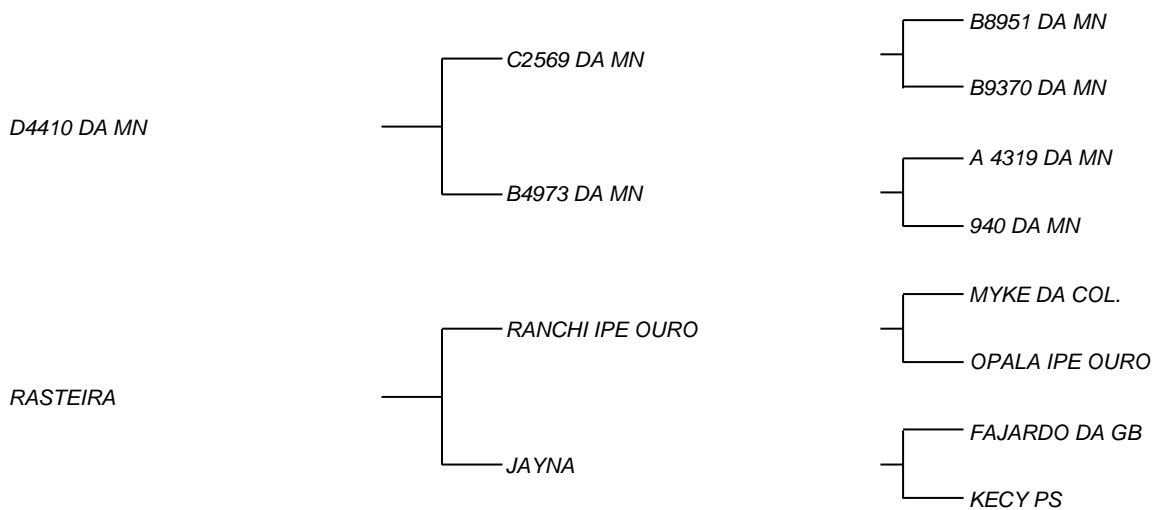

PESO: 630 KG. C.E.: 36 CM.



GUIATO DA MASSAVI

LOTE: 007

VENDEDOR(ES): AGROPECUARIA SANTA LUCIA

QTD.: 1

FAZENDA: AGROPECUARIA SANTA LUCIA

MSVI 2482 - NELORE - MACHO - NASC.:21/04/2016 - IDADE: 24 MS

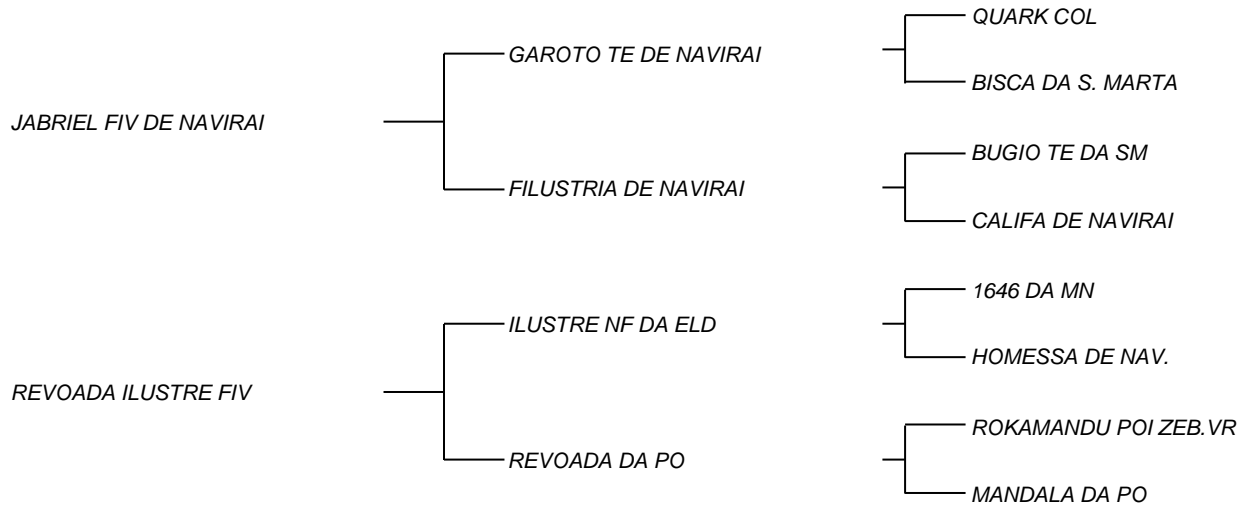

PESO: 600 KG. C.E.: 35 CM.

GABARITO DA MASSAVI

LOTE: 008

VENDEDOR(ES): AGROPECUARIA SANTA LUCIA

QTD.: 1

FAZENDA: AGROPECUARIA SANTA LUCIA

MSVI 2461 - NELORE - MACHO - NASC.:12/04/2016 - IDADE: 25 MS - BRANCA

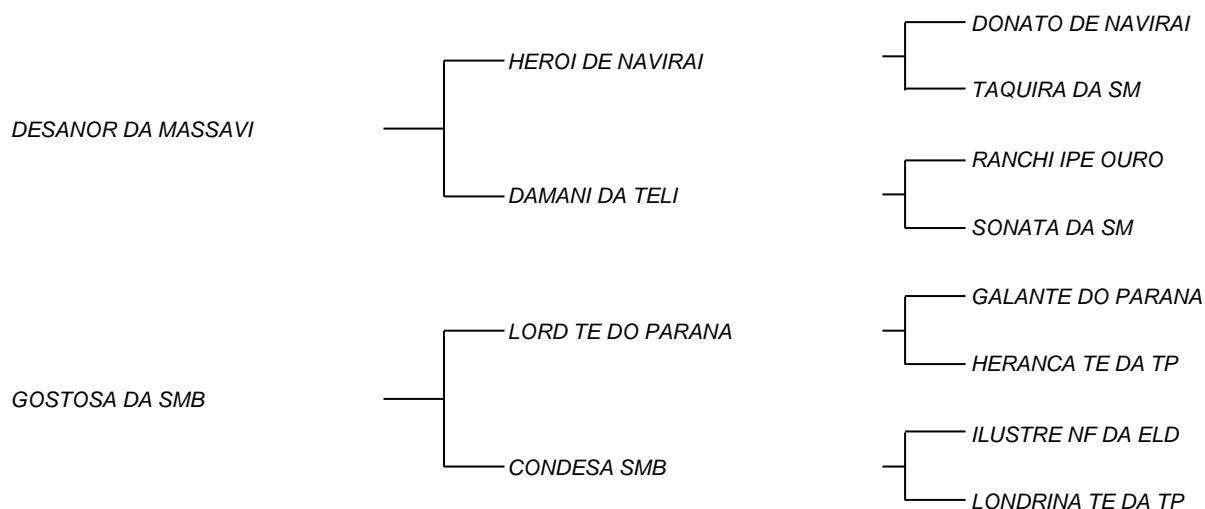

PESO: 595 KG. C.E.: 34 CM.



GALEGO DA MASSAVI

LOTE: 010

VENDEDOR(ES): AGROPECUARIA SANTA LUCIA

QTD.: 1

FAZENDA: AGROPECUARIA SANTA LUCIA

MSVI 2504 - NELORE - MACHO - NASC.:25/04/2016 - IDADE: 24 MS

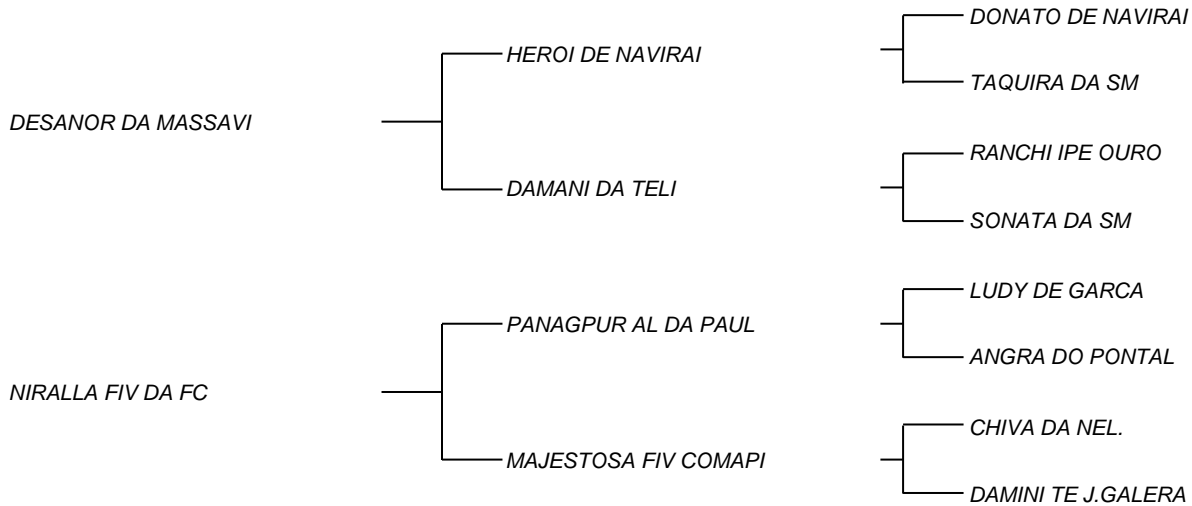

PESO: 570 KG. C.E.: 34 CM.

GAJO DA MASSAVI

LOTE: 011

VENDEDOR(ES): AGROPECUARIA SANTA LUCIA

QTD.: 1

FAZENDA: AGROPECUARIA SANTA LUCIA

MSVI 2287 - NELORE - MACHO - NASC.:07/01/2016 - IDADE: 28 MS

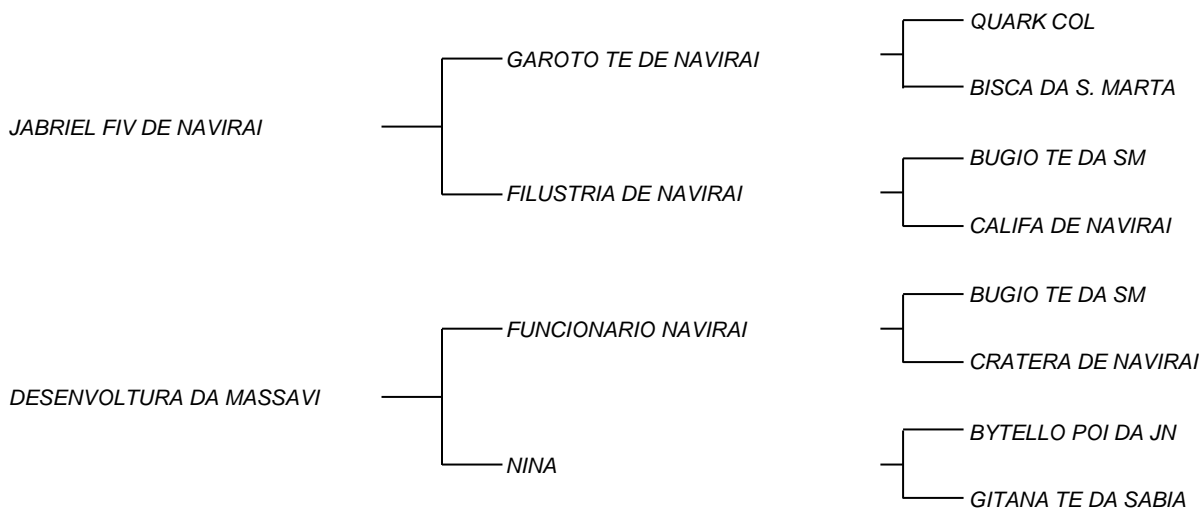

PESO: 620 KG. C.E.: 36 CM.



GURI DA MASSAVI

LOTE: 012

VENDEDOR(ES): AGROPECUARIA SANTA LUCIA

QTD.: 1

FAZENDA: AGROPECUARIA SANTA LUCIA

MSVI 2554 - NELORE - MACHO - NASC.:01/06/2016 - IDADE: 23 MS

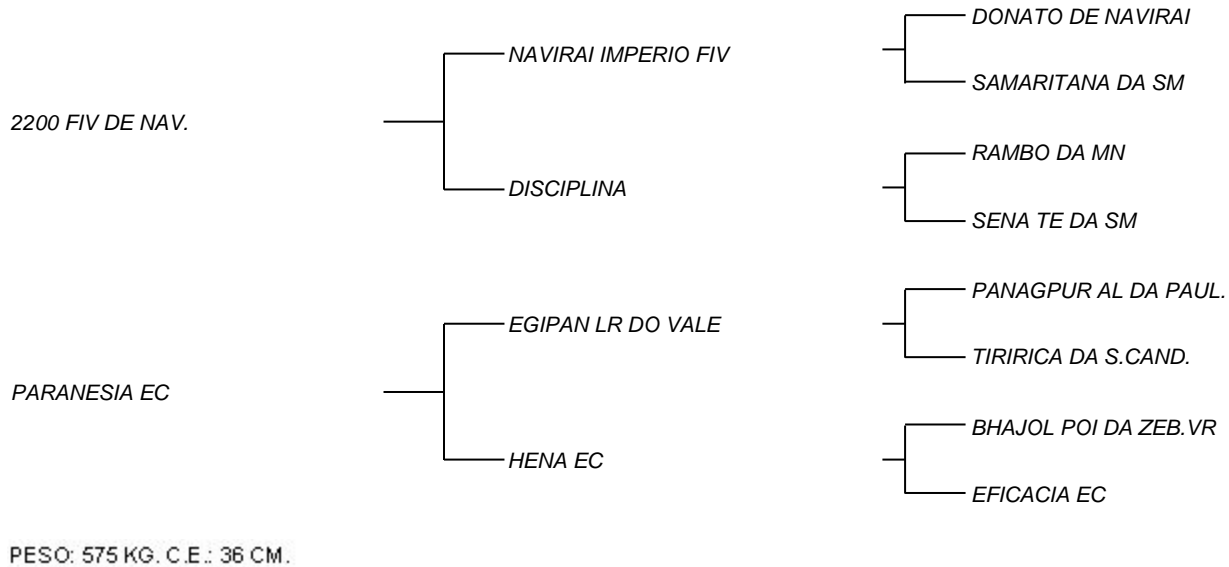

GIBOSO DA MASSAVI

LOTE: 013

VENDEDOR(ES): AGROPECUARIA SANTA LUCIA

QTD.: 1

FAZENDA: AGROPECUARIA SANTA LUCIA

MSVI 2599 - NELORE - MACHO - NASC.:15/08/2016 - IDADE: 20 MS

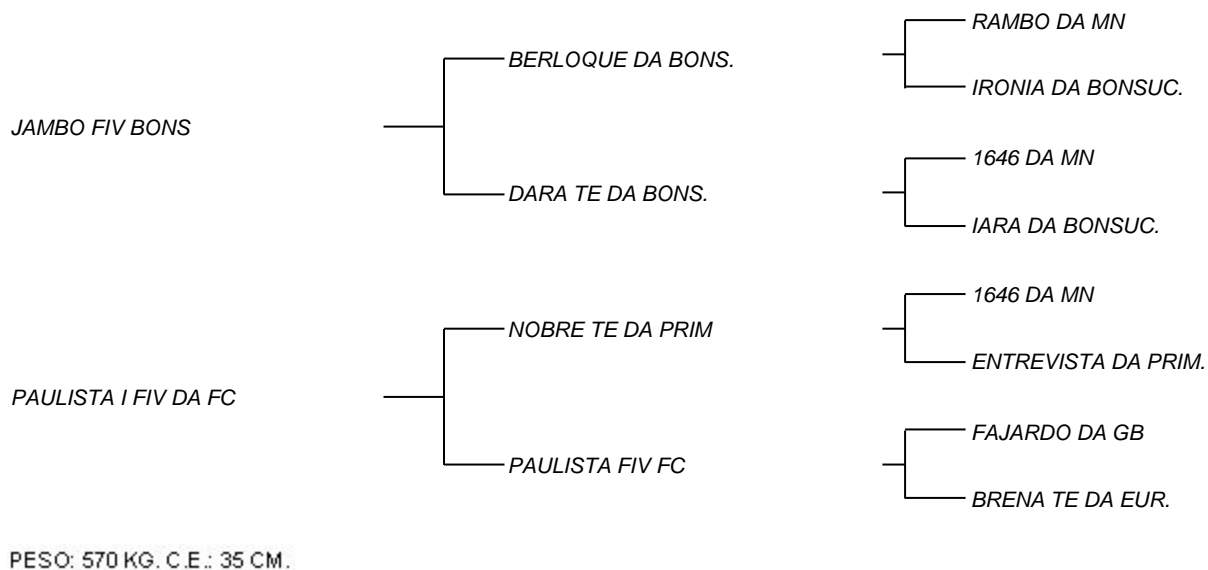



GALLO DA MASSAVI

LOTE: 015

VENDEDOR(ES): AGROPECUARIA SANTA LUCIA

QTD.: 1

FAZENDA: AGROPECUARIA SANTA LUCIA

MSVI 2512 - NELORE - MACHO - NASC.:29/04/2016 - IDADE: 24 MS

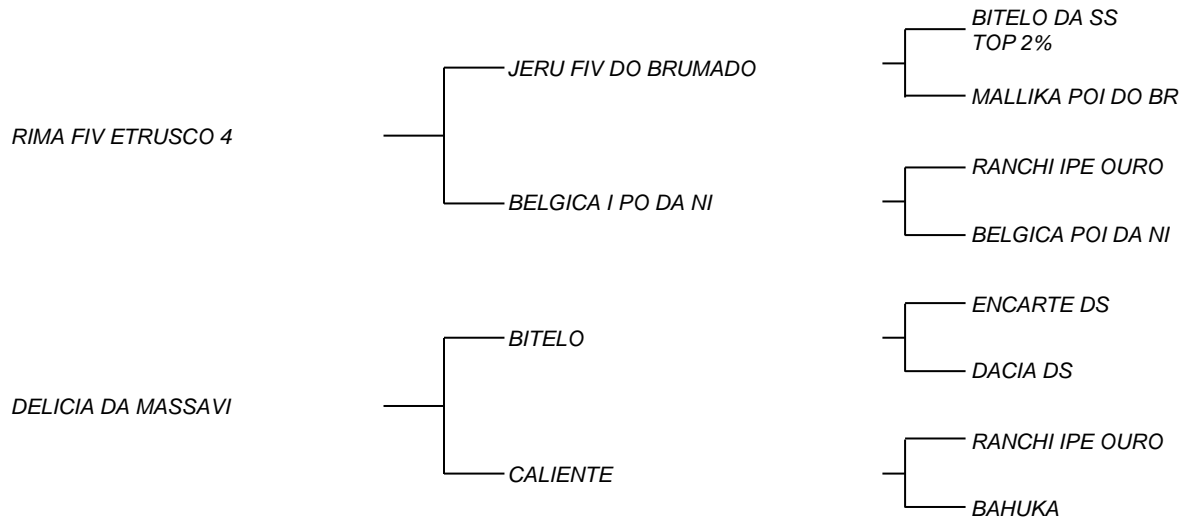

PESO: 650 KG. C.E.: 38 CM.

GIGANTESCO DA MASSAVI

LOTE: 016

VENDEDOR(ES): AGROPECUARIA SANTA LUCIA

QTD.: 1

FAZENDA: AGROPECUARIA SANTA LUCIA

MSVI 2460 - NELORE - MACHO - NASC.:12/04/2016 - IDADE: 25 MS

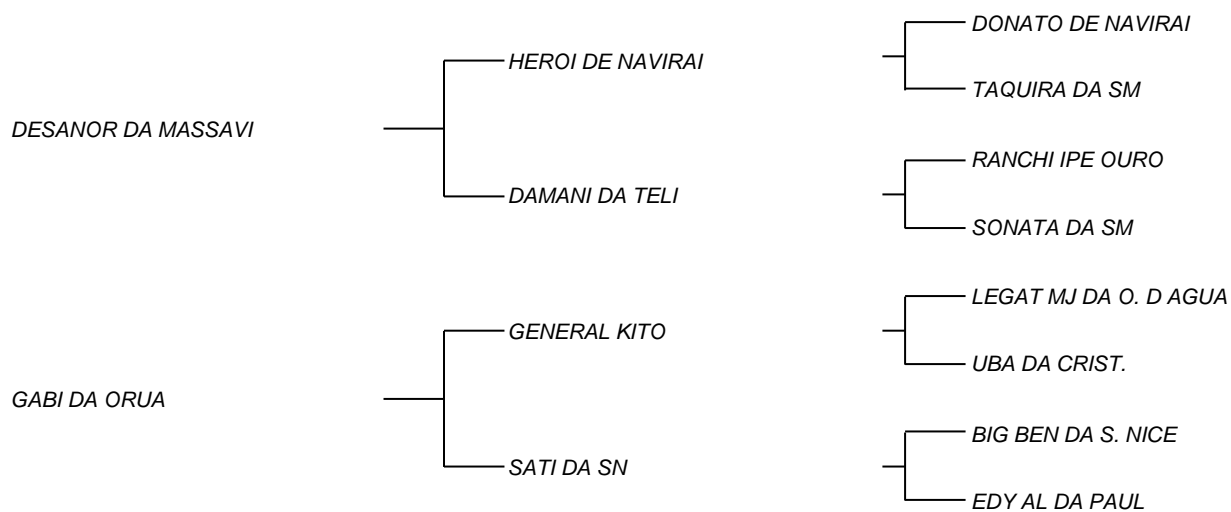

PESO: 645 KG. C.E.: 37 CM.



GALVAO DA MASSAVI

LOTE: 017

VENDEDOR(ES): AGROPECUARIA SANTA LUCIA

QTD.: 1

FAZENDA: AGROPECUARIA SANTA LUCIA

MSVI 2419 - NELORE - MACHO - NASC.:20/03/2016 - IDADE: 25 MS

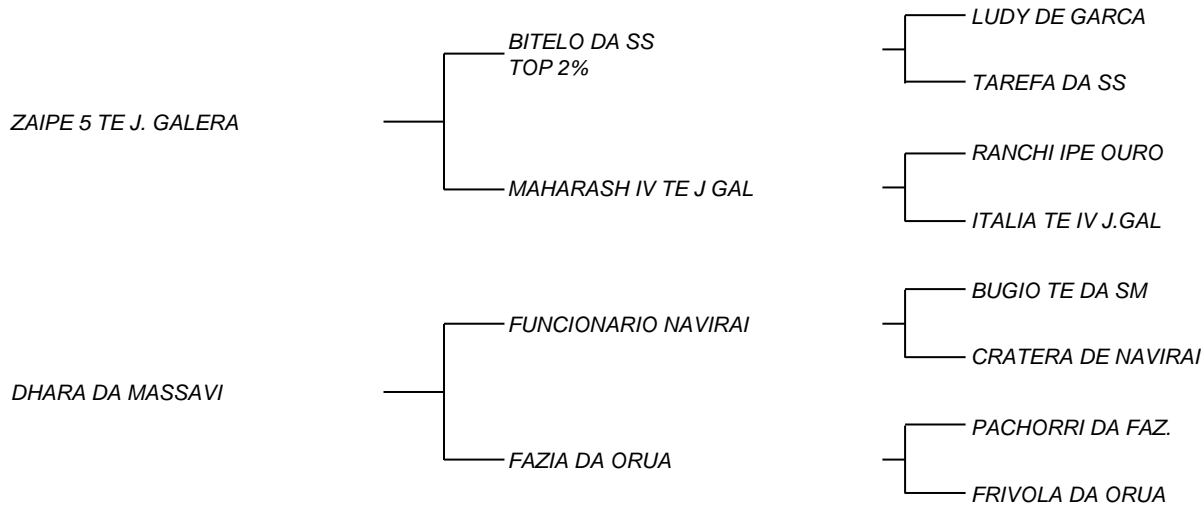

PESO: 618 KG. C.E.: 40 CM.

GELMO DA MASSAVI

LOTE: 018

VENDEDOR(ES): AGROPECUARIA SANTA LUCIA

QTD.: 1

FAZENDA: AGROPECUARIA SANTA LUCIA

MSVI 2498 - NELORE - MACHO - NASC.:23/04/2016 - IDADE: 24 MS

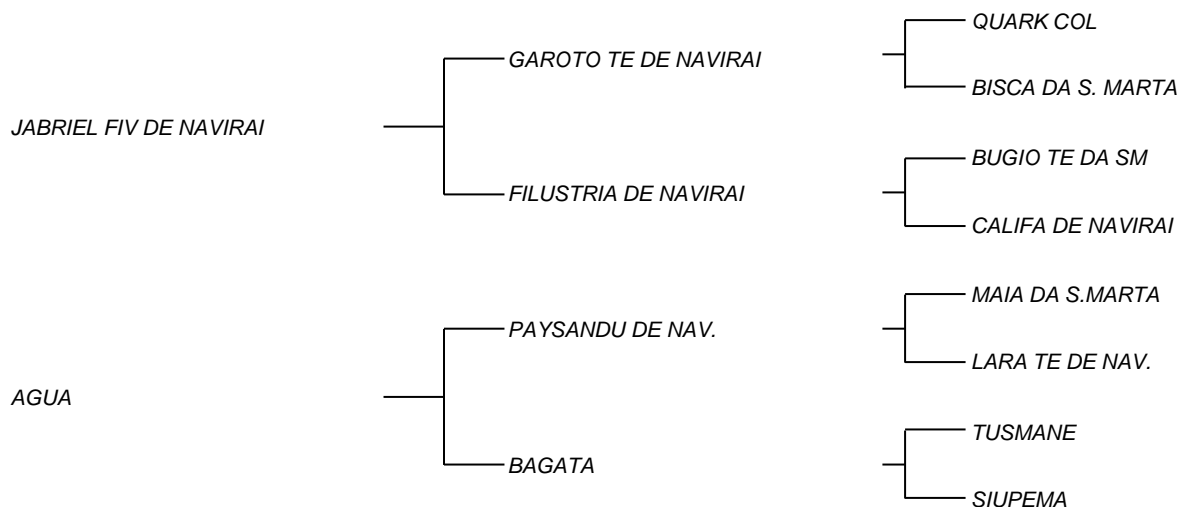

PESO: 580 KG. C.E.: 34 CM.



GALDERIO DA MASSAVI

LOTE: 019

VENDEDOR(ES): AGROPECUARIA SANTA LUCIA

QTD.: 1

FAZENDA: AGROPECUARIA SANTA LUCIA

MSVI 2648 - NELORE - MACHO - NASC.:19/09/2016 - IDADE: 19 MS

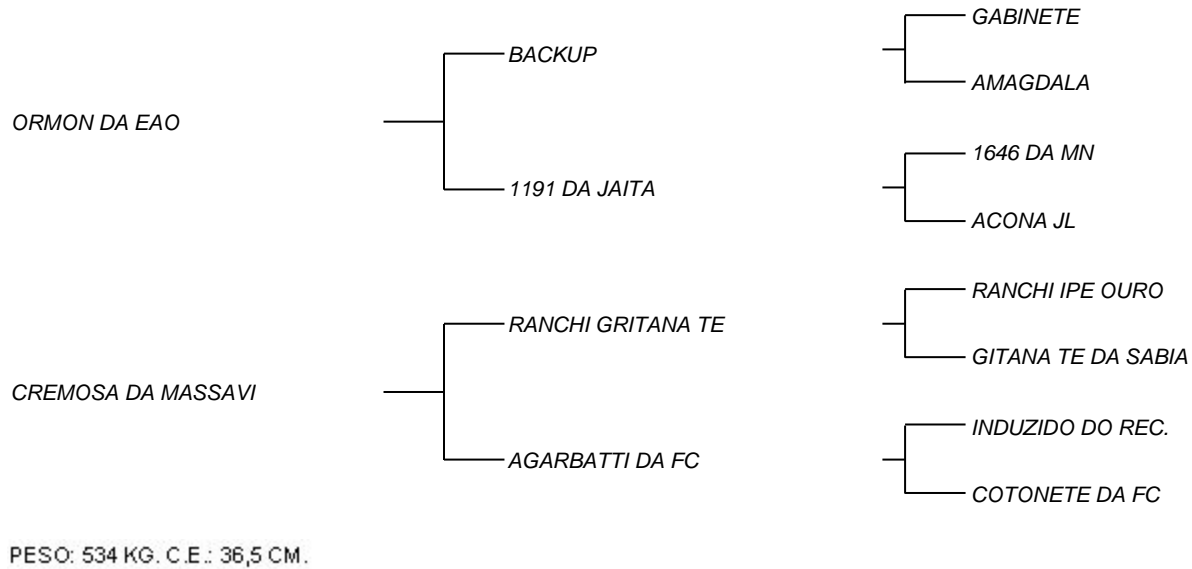

GRATAO DA MASSAVI

LOTE: 020

VENDEDOR(ES): AGROPECUARIA SANTA LUCIA

QTD.: 1

FAZENDA: AGROPECUARIA SANTA LUCIA

MSVI 2597 - NELORE - MACHO - NASC.:15/08/2016 - IDADE: 20 MS

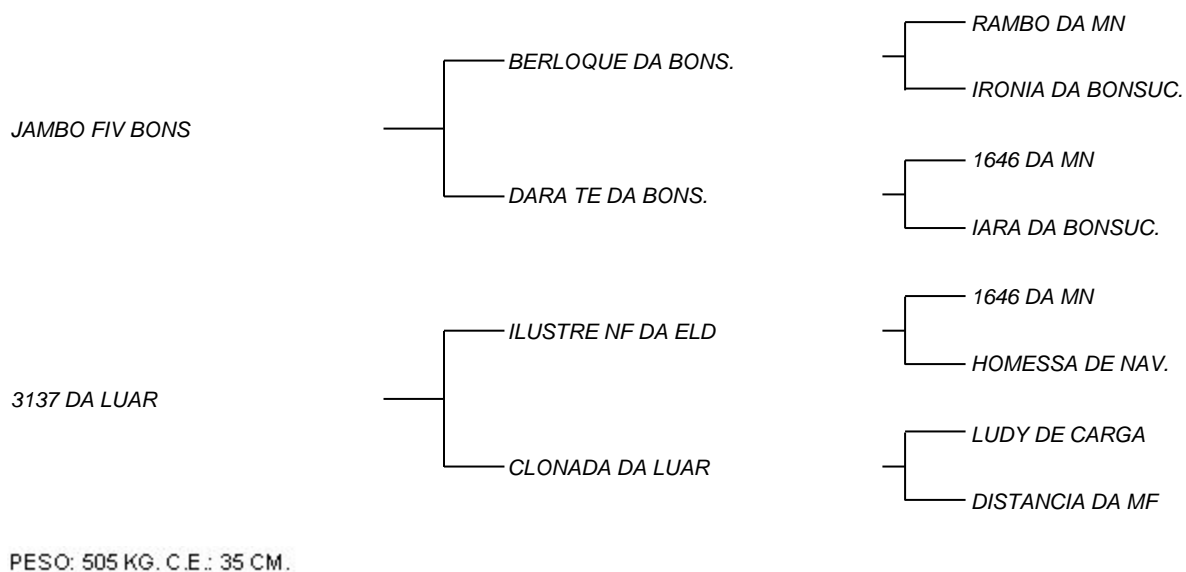



GALPAO DA MASSAVI

LOTE: 021

VENDEDOR(ES): AGROPECUARIA SANTA LUCIA

QTD.: 1

FAZENDA: AGROPECUARIA SANTA LUCIA

MSVI 2598 - NELORE - MACHO - NASC.:15/08/2016 - IDADE: 20 MS

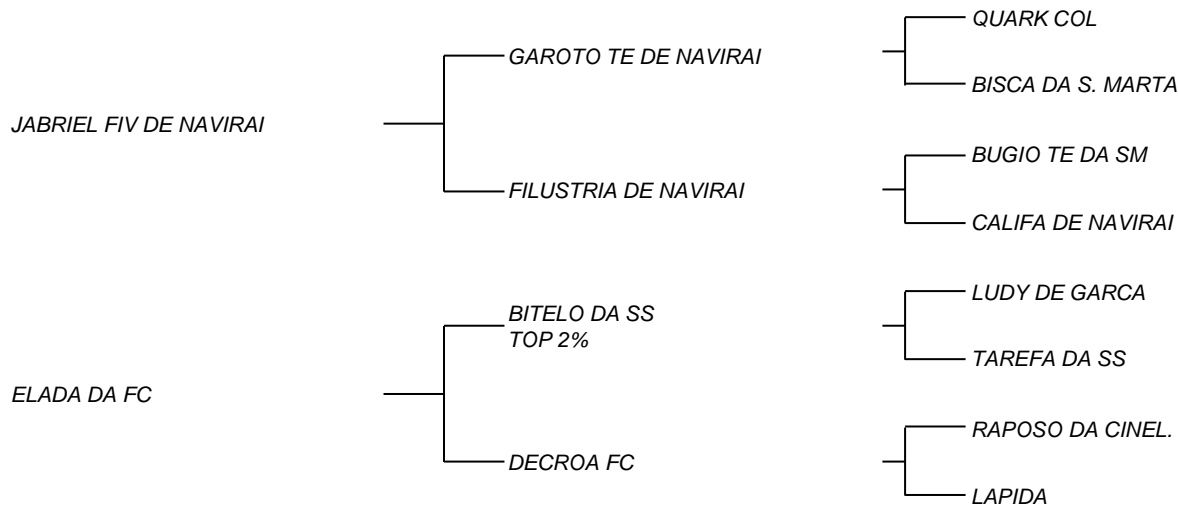

PESO: 529 KG. C.E.: 37 CM.

GRUDE DA MASSAVI

LOTE: 022

VENDEDOR(ES): AGROPECUARIA SANTA LUCIA

QTD.: 1

FAZENDA: AGROPECUARIA SANTA LUCIA

MSVI 2706 - NELORE - MACHO - NASC.:13/10/2016 - IDADE: 19 MS

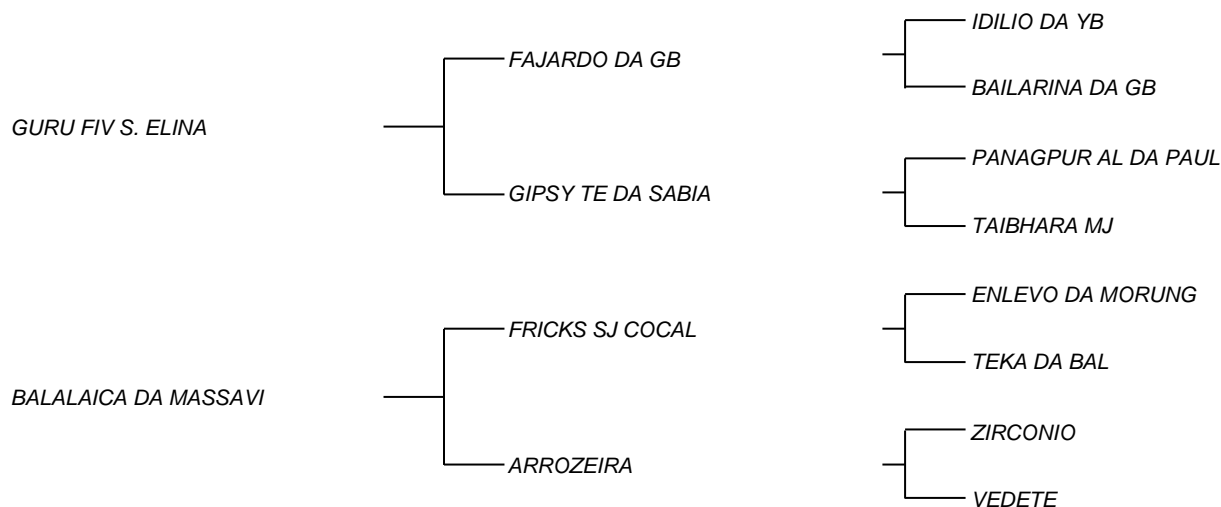

PESO: 554 KG. C.E.: 37,5 CM.



GAETANO DA MASSAVI

LOTE: 023

VENDEDOR(ES): AGROPECUARIA SANTA LUCIA

QTD.: 1

FAZENDA: AGROPECUARIA SANTA LUCIA

MSVI 2595 - NELORE - MACHO - NASC.:14/08/2016 - IDADE: 21 MS

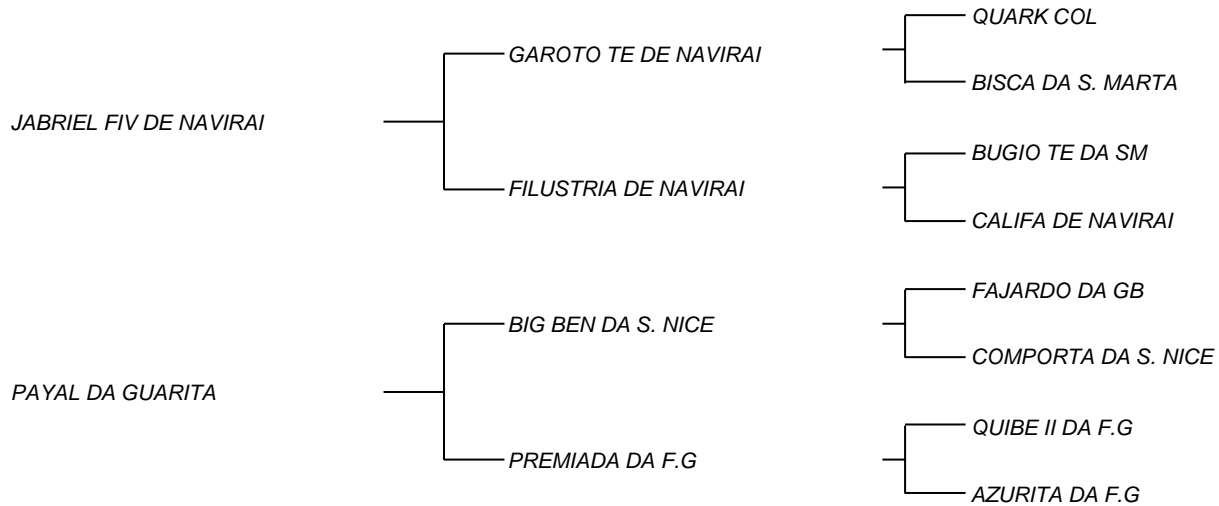

PESO: 506 KG. C.E.: 35 CM.

GENIO DA MASSAVI

LOTE: 024

VENDEDOR(ES): AGROPECUARIA SANTA LUCIA

QTD.: 1

FAZENDA: AGROPECUARIA SANTA LUCIA

MSVI 2476 - NELORE - MACHO - NASC.:18/04/2016 - IDADE: 24 MS

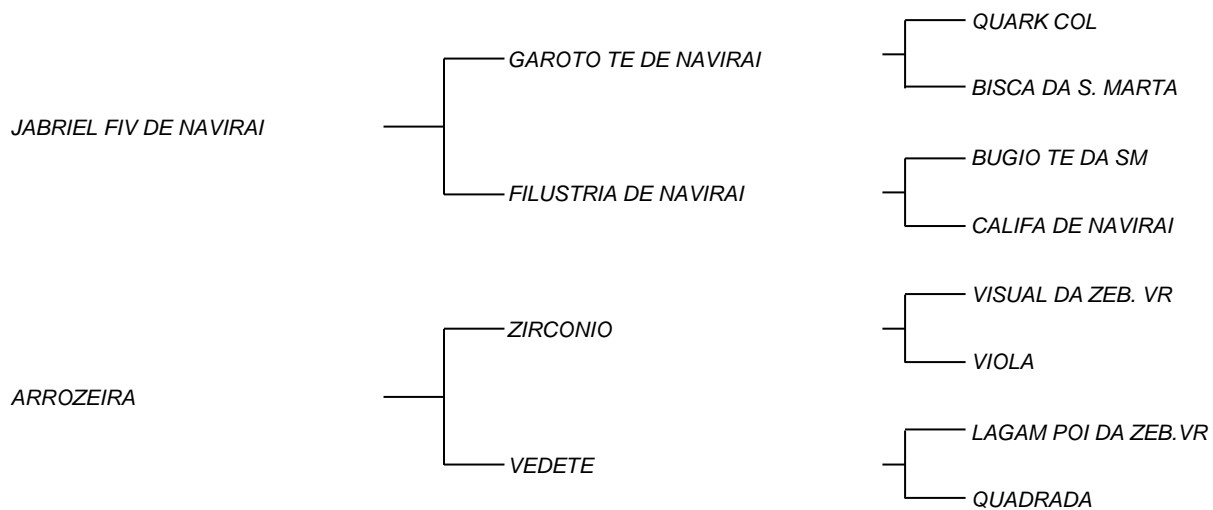

PESO: 520 KG. C.E.: 37,5 CM.



GERUNDIO DA MASSAVI

LOTE: 025

VENDEDOR(ES): AGROPECUARIA SANTA LUCIA

QTD.: 1

FAZENDA: AGROPECUARIA SANTA LUCIA

MSVI 2653 - NELORE - MACHO - NASC.:21/09/2016 - IDADE: 19 MS

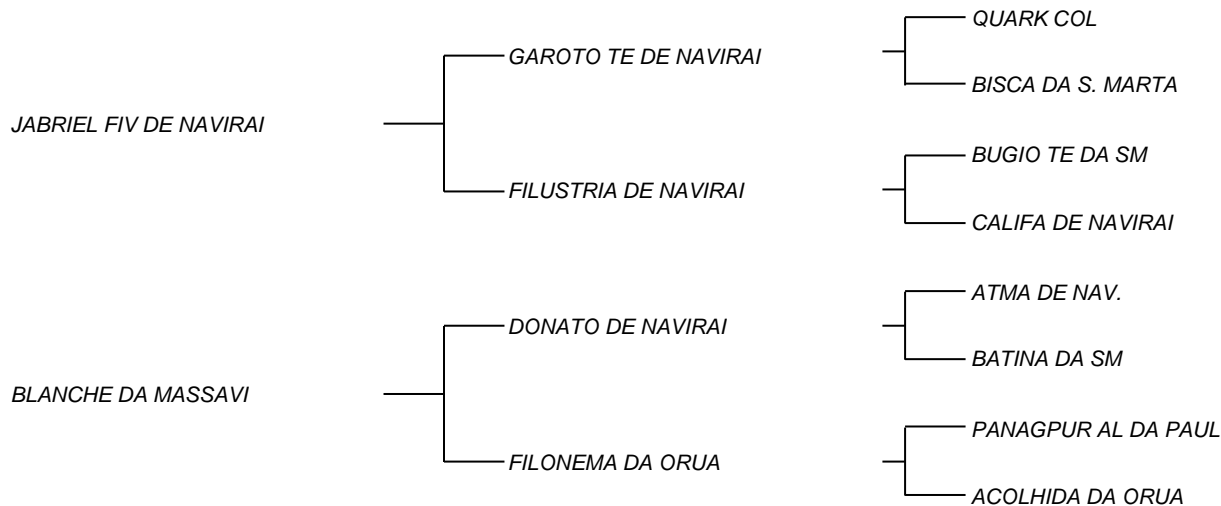

PESO: 475 KG. C.E.: 35 CM.

GRATUNO DA MASSAVI

LOTE: 026

VENDEDOR(ES): AGROPECUARIA SANTA LUCIA

QTD.: 1

FAZENDA: AGROPECUARIA SANTA LUCIA

MSVI 2565 - NELORE - MACHO - NASC.:23/07/2016 - IDADE: 21 MS

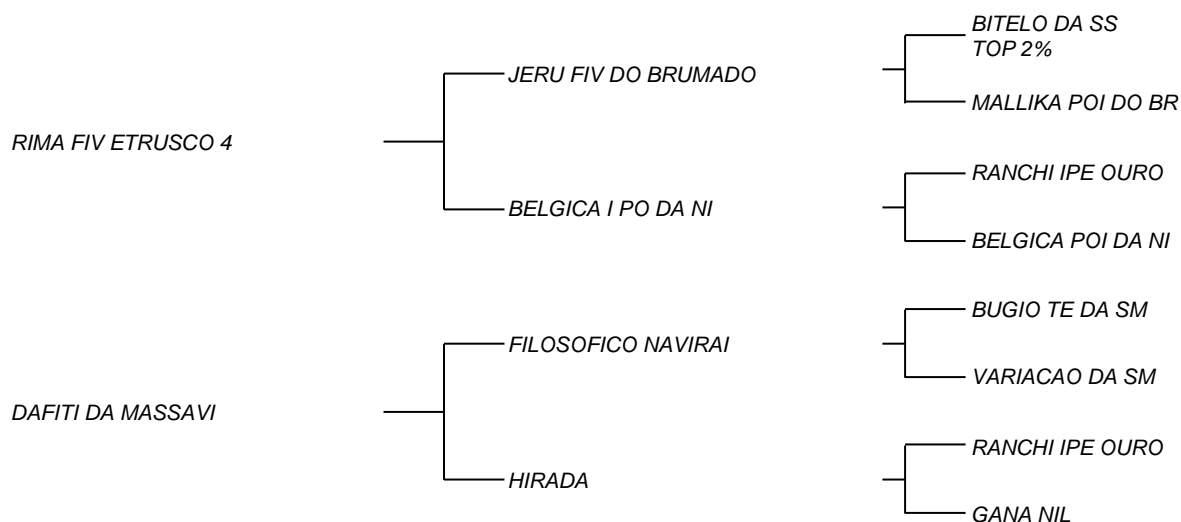

PESO: 490 KG. C.E.: 35 CM.



GUDE DA MASSAVI

LOTE: 027

VENDEDOR(ES): AGROPECUARIA SANTA LUCIA

QTD.: 1

FAZENDA: AGROPECUARIA SANTA LUCIA

MSVI 2733 - NELORE - MACHO - NASC.:23/10/2016 - IDADE: 18 MS

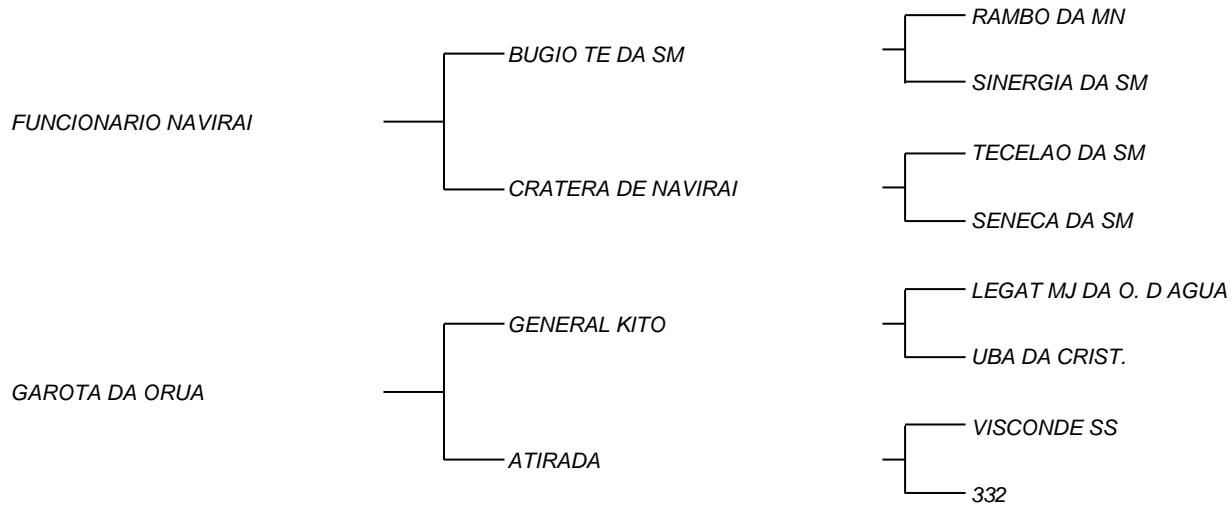

PESO: 445 KG. C.E.: 33 CM.

GUAIRO DA MASSAVI

LOTE: 028

VENDEDOR(ES): AGROPECUARIA SANTA LUCIA

QTD.: 1

FAZENDA: AGROPECUARIA SANTA LUCIA

MSVI 2728 - NELORE - MACHO - NASC.:19/10/2016 - IDADE: 18 MS

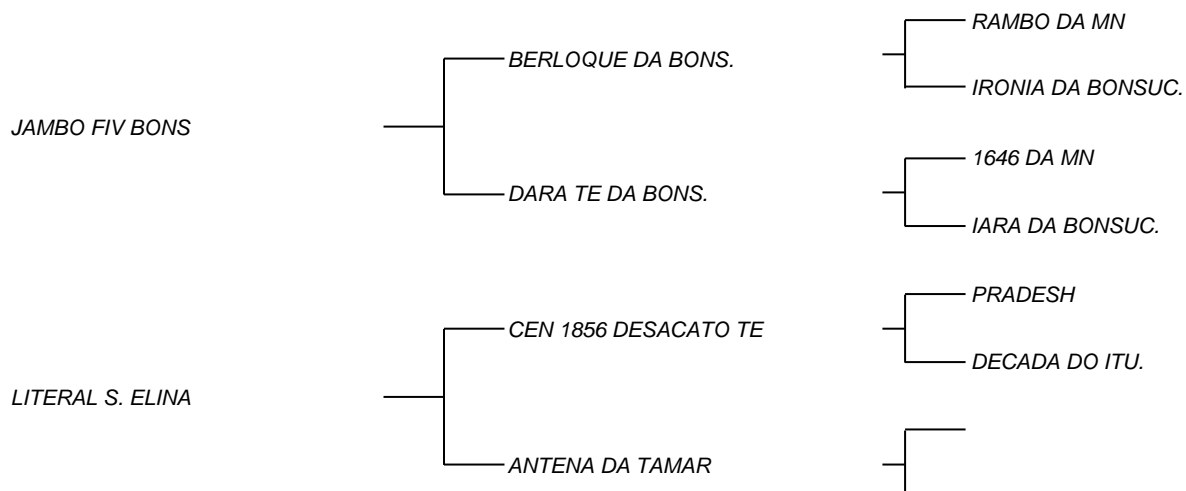

PESO: 502 KG. C.E.: 37 CM.



GENERICO DA MASSAVI

LOTE: 029

VENDEDOR(ES): AGROPECUARIA SANTA LUCIA

QTD.: 1

FAZENDA: AGROPECUARIA SANTA LUCIA

MSVI 2451 - NELORE - MACHO - NASC.:21/06/2016 - IDADE: 22 MS

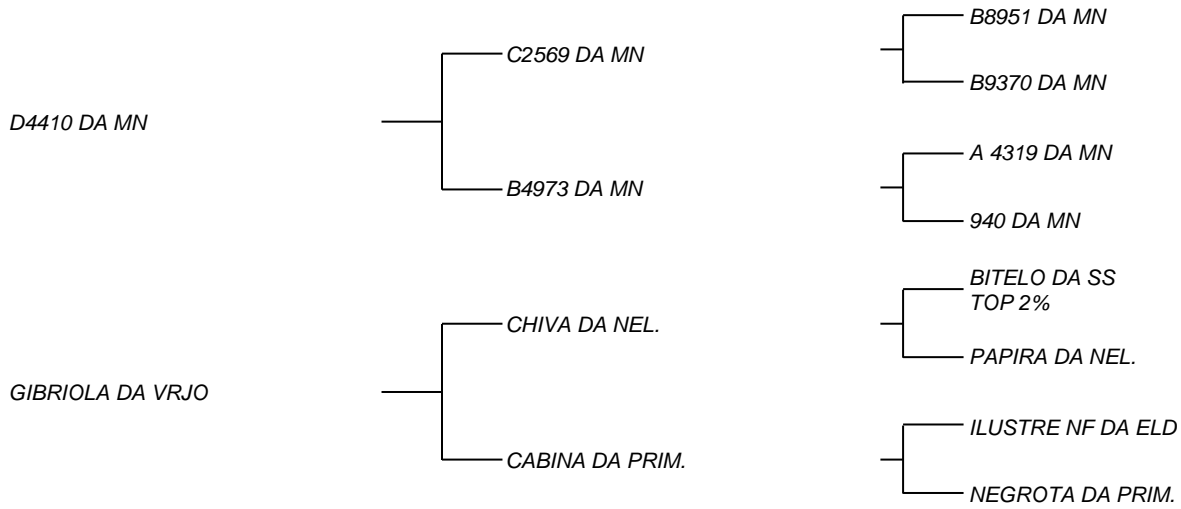

PESO: 530 KG. C.E.: 35 CM.

GATHUNO DA MASSAVI

LOTE: 030

VENDEDOR(ES): AGROPECUARIA SANTA LUCIA

QTD.: 1

FAZENDA: AGROPECUARIA SANTA LUCIA

MSVI 2618 - NELORE - MACHO - NASC.:22/08/2016 - IDADE: 20 MS

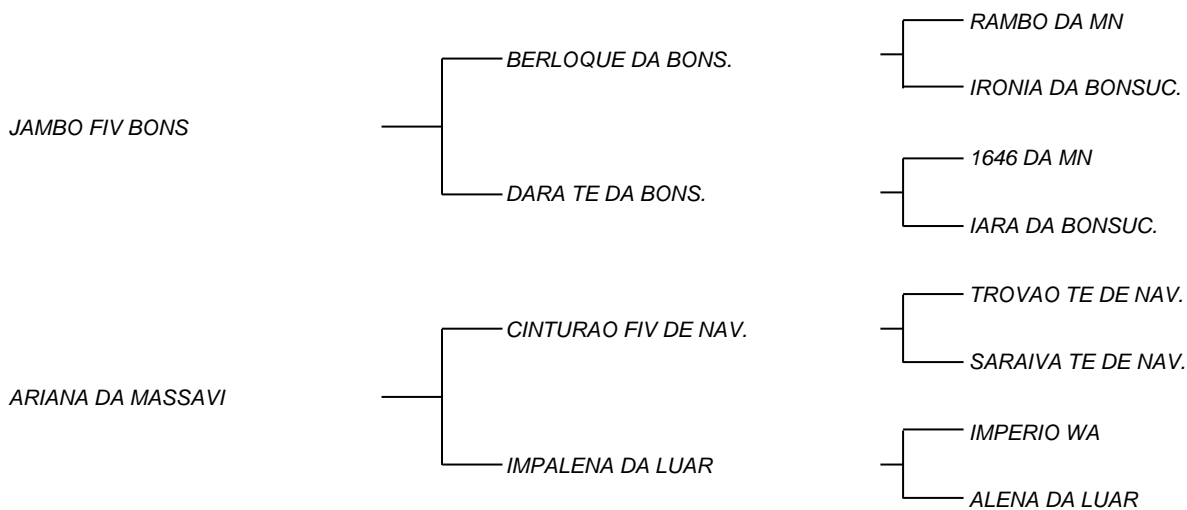

PESO: 508 KG. C.E.: 36 CM.



GUIMA DA MASSAVI

LOTE: 031

VENDEDOR(ES): AGROPECUARIA SANTA LUCIA

QTD.: 1

FAZENDA: AGROPECUARIA SANTA LUCIA

MSVI 2620 - NELORE - MACHO - NASC.:24/08/2016 - IDADE: 20 MS

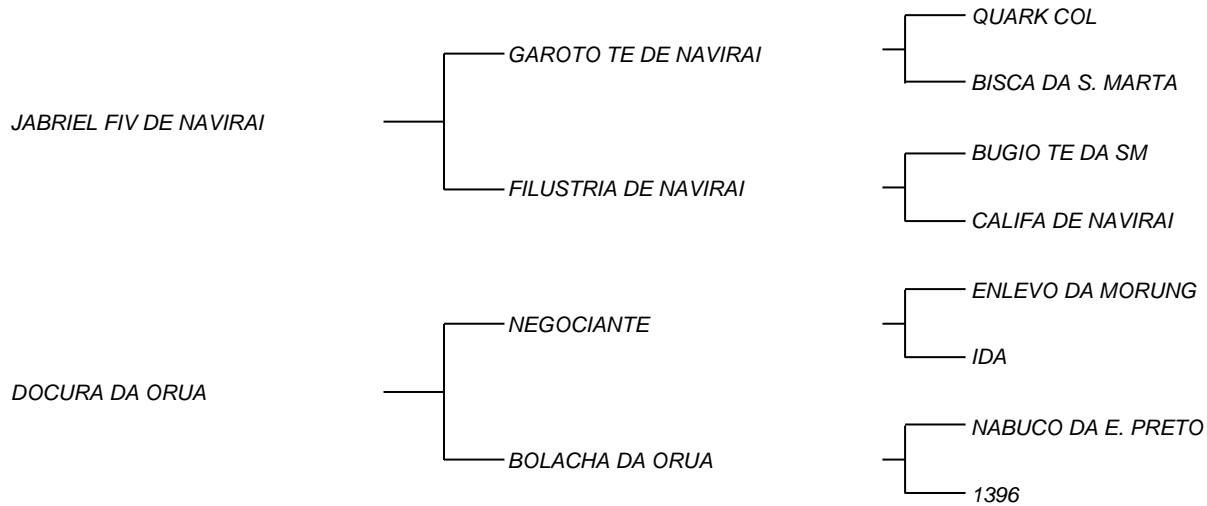

PESO: 551 KG. C.E.: 35 CM.

GENEBRA DA MASSAVI

LOTE: 032

VENDEDOR(ES): AGROPECUARIA SANTA LUCIA

QTD.: 1

FAZENDA: AGROPECUARIA SANTA LUCIA

MSVI 2588 - NELORE - MACHO - NASC.:12/08/2016 - IDADE: 21 MS

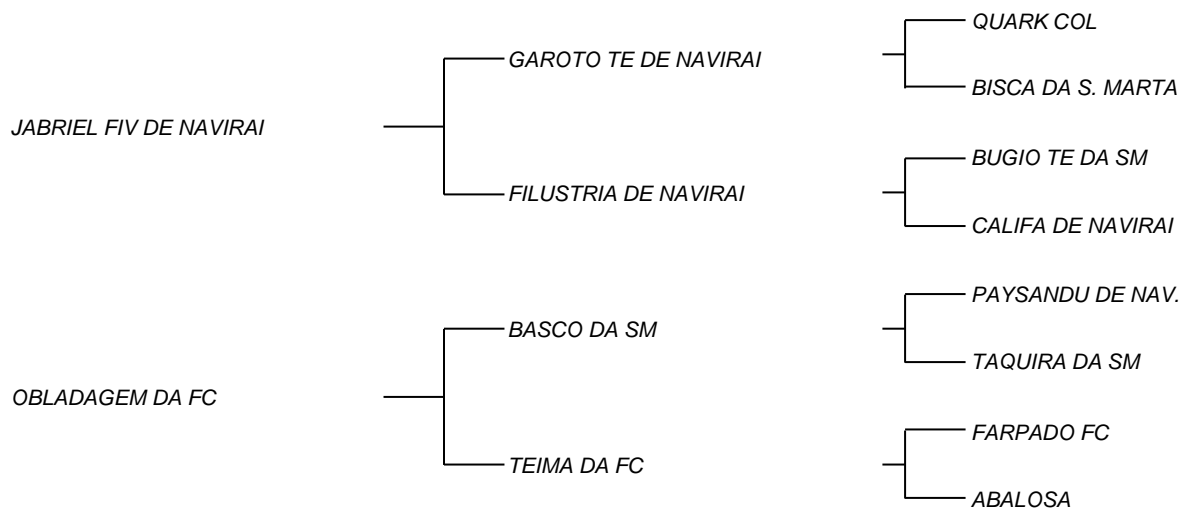

PESO: 531 KG. C.E.: 36 CM.



GRATIFICADO DA MASSAVI

LOTE: 033

VENDEDOR(ES): AGROPECUARIA SANTA LUCIA

QTD.: 1

FAZENDA: AGROPECUARIA SANTA LUCIA

MSVI 2666 - NELORE - MACHO - NASC.:25/09/2016 - IDADE: 19 MS

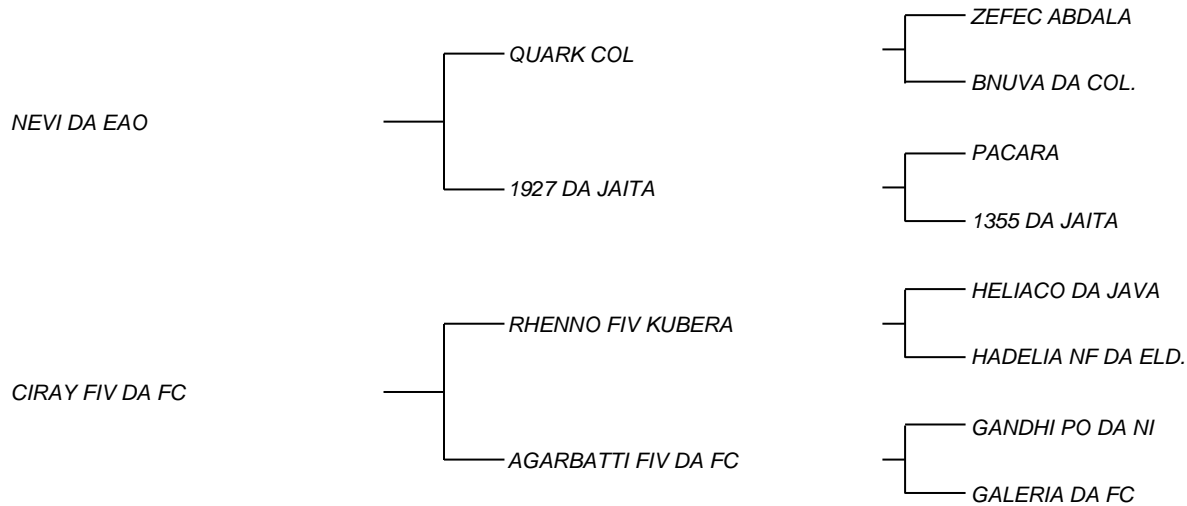

PESO: 520 KG. C.E.: 35 CM.

GOSPEL DA MASSAVI

LOTE: 034

VENDEDOR(ES): AGROPECUARIA SANTA LUCIA

QTD.: 1

FAZENDA: AGROPECUARIA SANTA LUCIA

MSVI 2631 - NELORE - MACHO - NASC.:07/09/2016 - IDADE: 20 MS

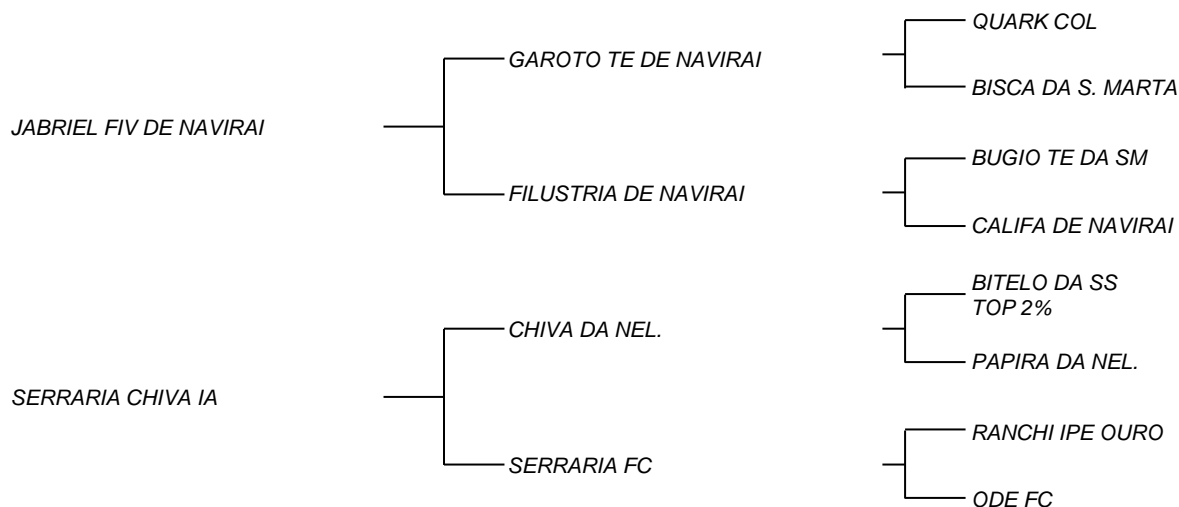

PESO: 520 KG. C.E.: 35 CM.



GAUDEIRO DA MASSAVI

LOTE: 035

VENDEDOR(ES): AGROPECUARIA SANTA LUCIA

QTD.: 1

FAZENDA: AGROPECUARIA SANTA LUCIA

MSVI 2436 - NELORE - MACHO - NASC.:30/03/2016 - IDADE: 25 MS

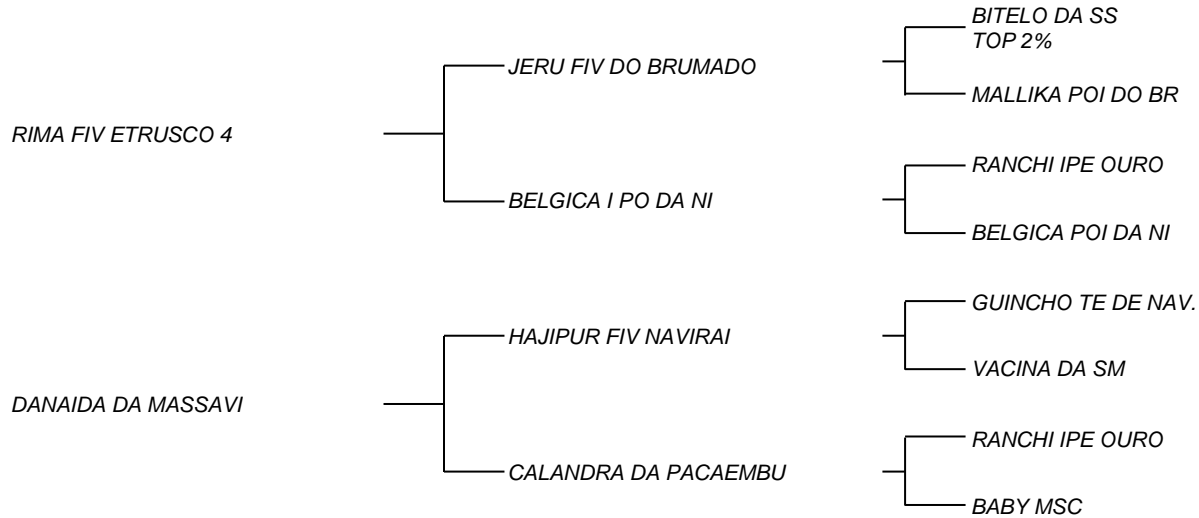

PESO: 505 KG. C.E.: 34 CM.

GELLI DA MASSAVI

LOTE: 036

VENDEDOR(ES): AGROPECUARIA SANTA LUCIA

QTD.: 1

FAZENDA: AGROPECUARIA SANTA LUCIA

MSVI 2493 - NELORE - MACHO - NASC.:21/04/2016 - IDADE: 24 MS

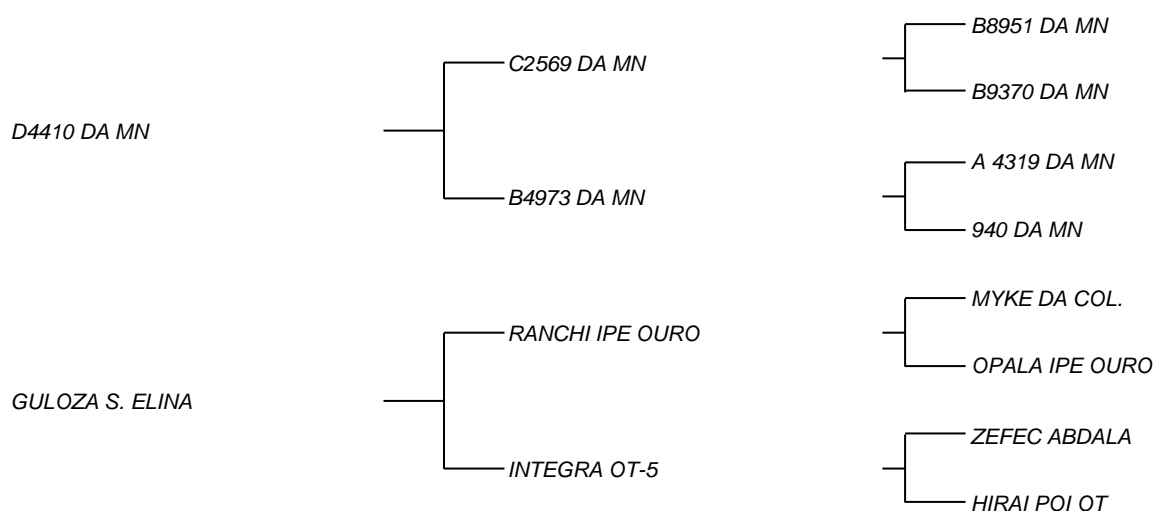

PESO: 605 KG. C.E.: 39 CM.



GASOGENIO DA MASSAVI

LOTE: 037

VENDEDOR(ES): AGROPECUARIA SANTA LUCIA

QTD.: 1

FAZENDA: AGROPECUARIA SANTA LUCIA

MSVI 2581 - NELORE - MACHO - NASC.:09/08/2016 - IDADE: 21 MS

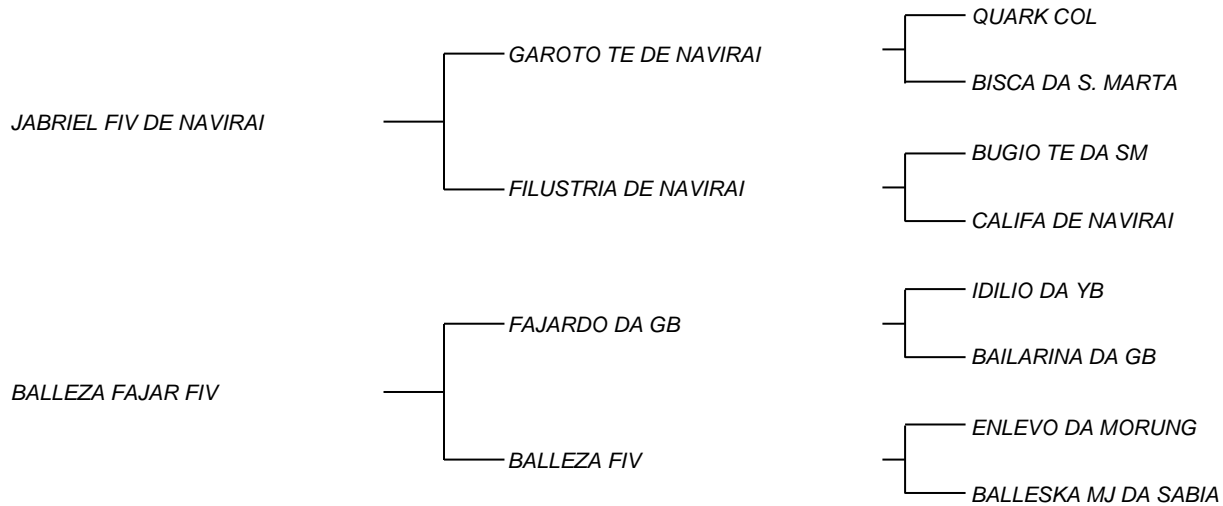

PESO: 570 KG. C.E.: 40 CM.

GIRARD DA MASSAVI

LOTE: 038

VENDEDOR(ES): AGROPECUARIA SANTA LUCIA

QTD.: 1

FAZENDA: AGROPECUARIA SANTA LUCIA

MSVI 2418 - NELORE - MACHO - NASC.:18/03/2016 - IDADE: 25 MS

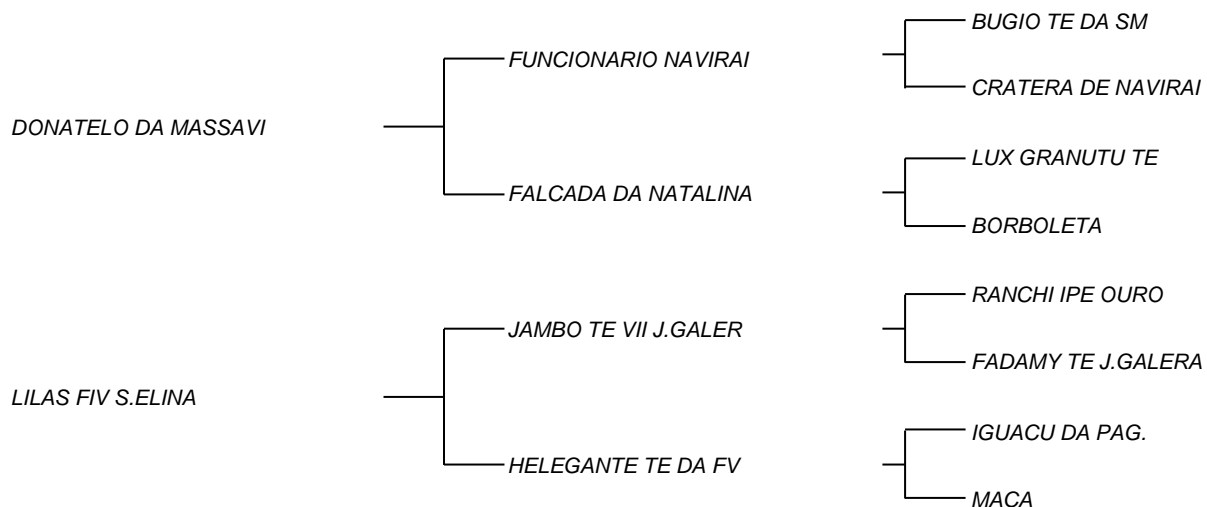

PESO: 631 KG. C.E.: 34 CM.



GUTHO DA MASSAVI

LOTE: 039

VENDEDOR(ES): AGROPECUARIA SANTA LUCIA

QTD.: 1

FAZENDA: AGROPECUARIA SANTA LUCIA

MSVI 2560 - NELORE - MACHO - NASC.:22/06/2016 - IDADE: 22 MS

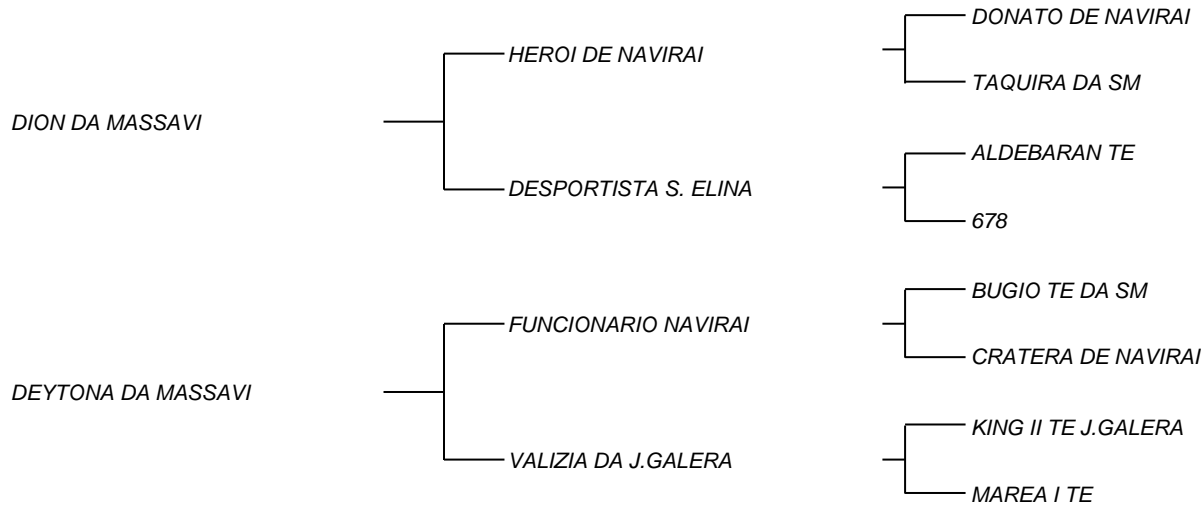

PESO: 603 KG. C.E.: 36,5 CM.

GIGANTE DA MASSAVI

LOTE: 040

VENDEDOR(ES): AGROPECUARIA SANTA LUCIA

QTD.: 1

FAZENDA: AGROPECUARIA SANTA LUCIA

MSVI 2449 - NELORE - MACHO - NASC.:06/04/2016 - IDADE: 25 MS

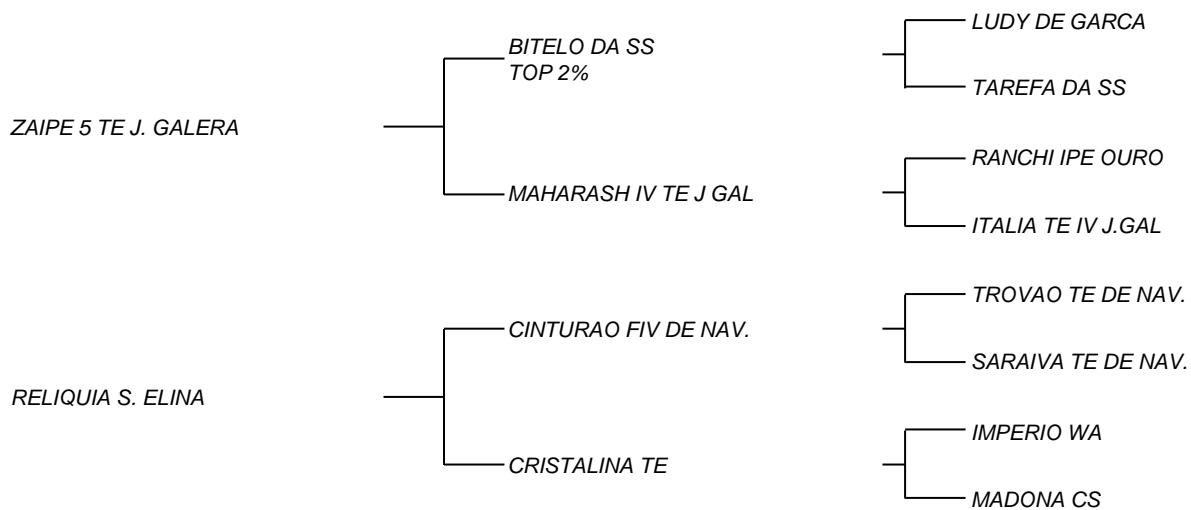

PESO: 586 KG. C.E.: 37,5 CM.



GERMAN DA MASSAVI

LOTE: 041

VENDEDOR(ES): AGROPECUARIA SANTA LUCIA

QTD.: 1

FAZENDA: AGROPECUARIA SANTA LUCIA

MSVI 2393 - NELORE - MACHO - NASC.:18/02/2016 - IDADE: 26 MS

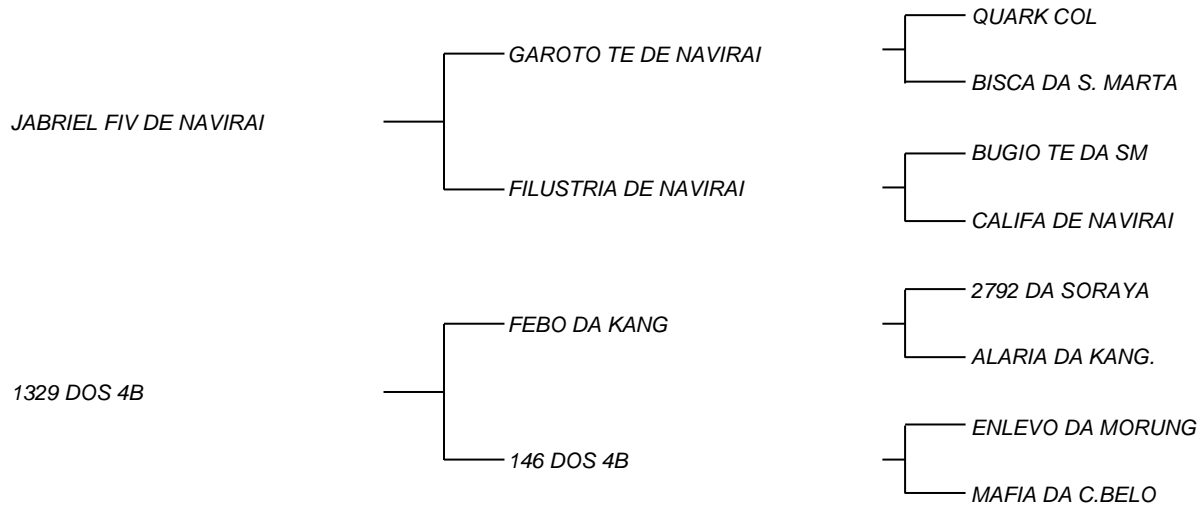

PESO: 595 KG. C.E.: 36,5 CM.

GELO DA MASSAVI

LOTE: 042

VENDEDOR(ES): AGROPECUARIA SANTA LUCIA

QTD.: 1

FAZENDA: AGROPECUARIA SANTA LUCIA

MSVI 2479 - NELORE - MACHO - NASC.:19/04/2016 - IDADE: 24 MS

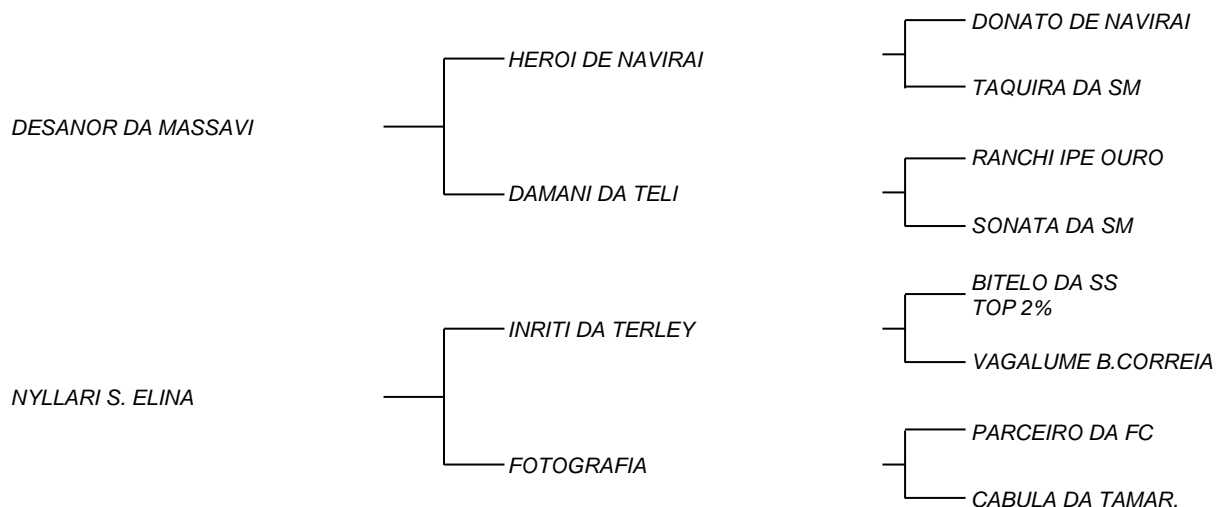

PESO: 587 KG. C.E.: 35 CM.



GARGAREJO DA MASSAVI

LOTE: 044

VENDEDOR(ES): AGROPECUARIA SANTA LUCIA

QTD.: 1

FAZENDA: AGROPECUARIA SANTA LUCIA

MSVI 2503 - NELORE - MACHO - NASC.:25/04/2016 - IDADE: 24 MS

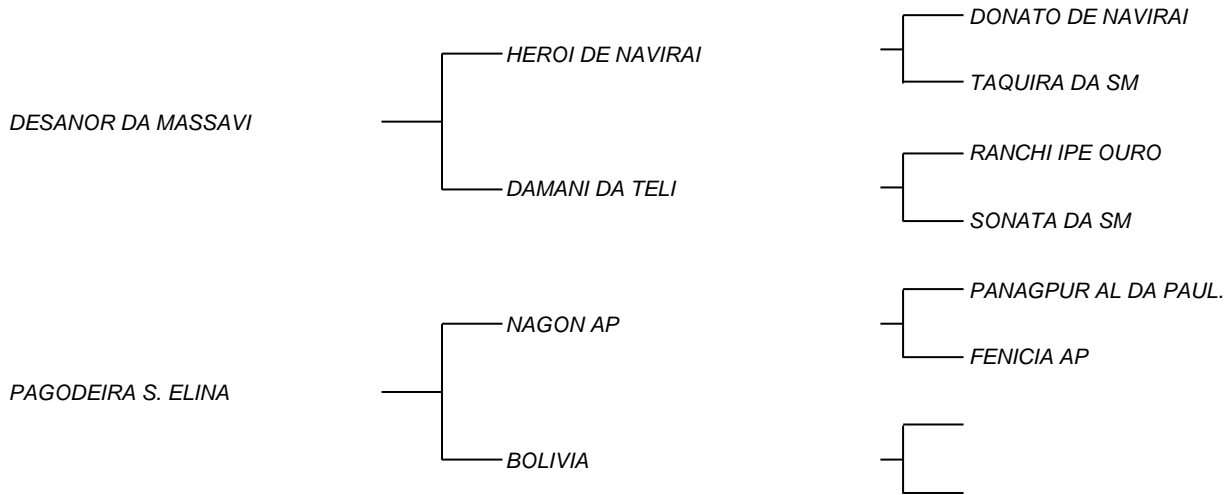

PESO: 570 KG. C.E.: 35 CM.

GRECO DA MASSAVI

LOTE: 045

VENDEDOR(ES): AGROPECUARIA SANTA LUCIA

QTD.: 1

FAZENDA: AGROPECUARIA SANTA LUCIA

MSVI 2524 - NELORE - MACHO - NASC.:06/05/2016 - IDADE: 24 MS

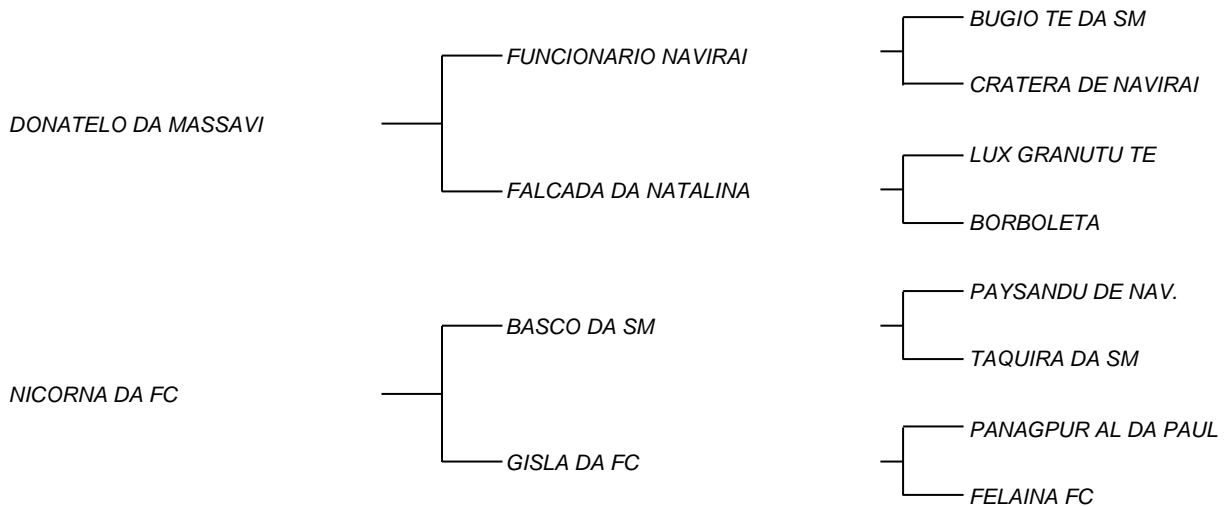

PESO: 577 KG. C.E.: 37 CM.



GENIOSO DA MASSAVI

LOTE: 046

VENDEDOR(ES): AGROPECUARIA SANTA LUCIA

QTD.: 1

FAZENDA: AGROPECUARIA SANTA LUCIA

MSVI 2545 - NELORE - MACHO - NASC.:23/05/2016 - IDADE: 23 MS

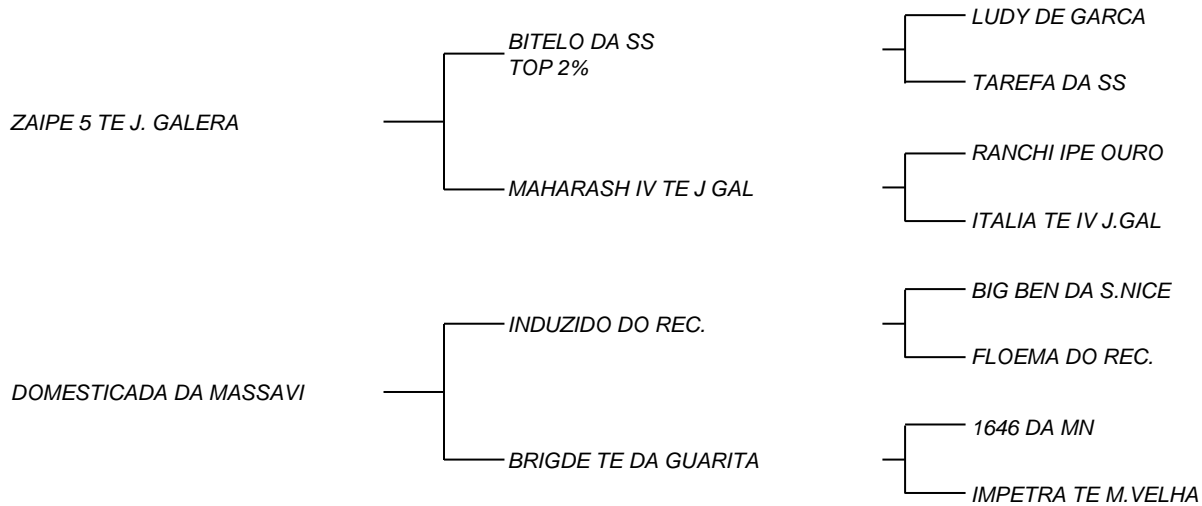

PESO: 565 KG. C.E.: 35 CM.

GIMMY DA MASSAVI

LOTE: 047

VENDEDOR(ES): AGROPECUARIA SANTA LUCIA

QTD.: 1

FAZENDA: AGROPECUARIA SANTA LUCIA

MSVI 2561 - NELORE - MACHO - NASC.:27/06/2016 - IDADE: 22 MS

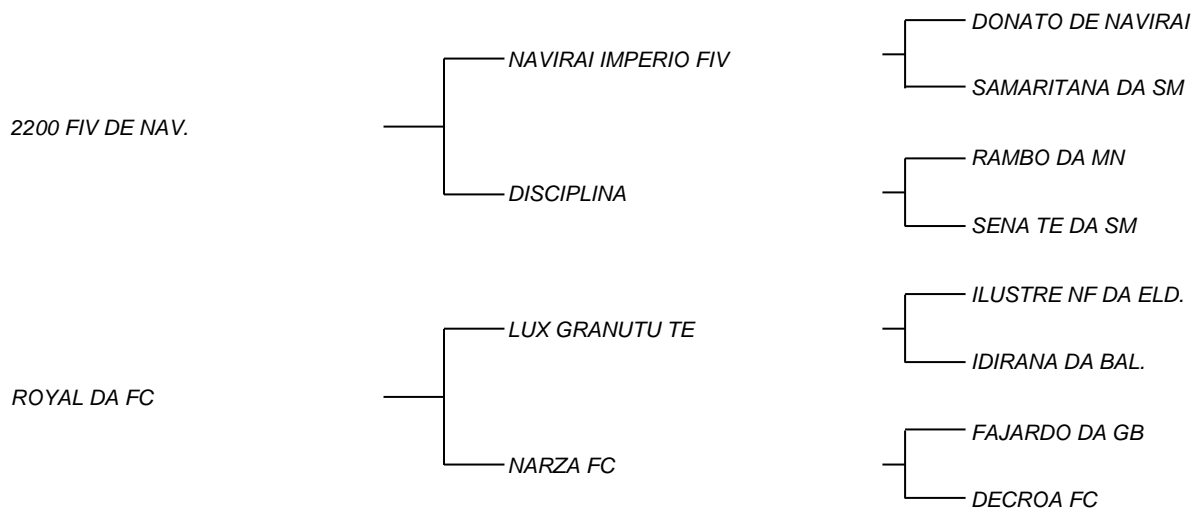

PESO: 584 KG. C.E.: 39 CM.



GALLENO DA MASSAVI

LOTE: 048

VENDEDOR(ES): AGROPECUARIA SANTA LUCIA

QTD.: 1

FAZENDA: AGROPECUARIA SANTA LUCIA

MSVI 2495 - NELORE - MACHO - NASC.:23/04/2016 - IDADE: 24 MS

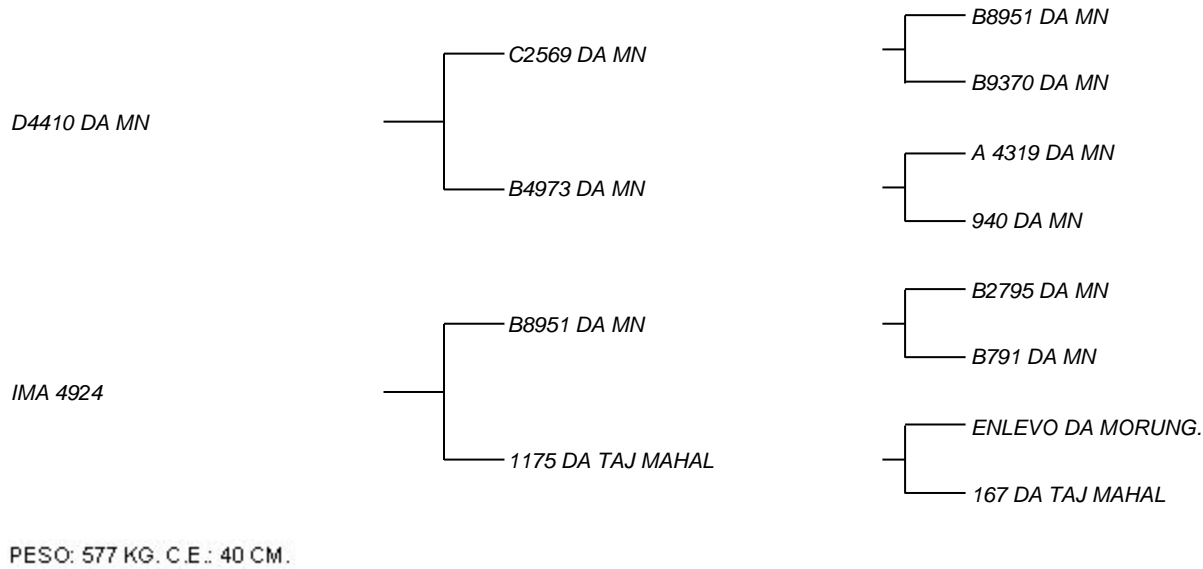

GONTIJO DA MASSAVI

LOTE: 049

VENDEDOR(ES): AGROPECUARIA SANTA LUCIA

QTD.: 1

FAZENDA: AGROPECUARIA SANTA LUCIA

MSVI 2574 - NELORE - MACHO - NASC.:06/08/2016 - IDADE: 21 MS

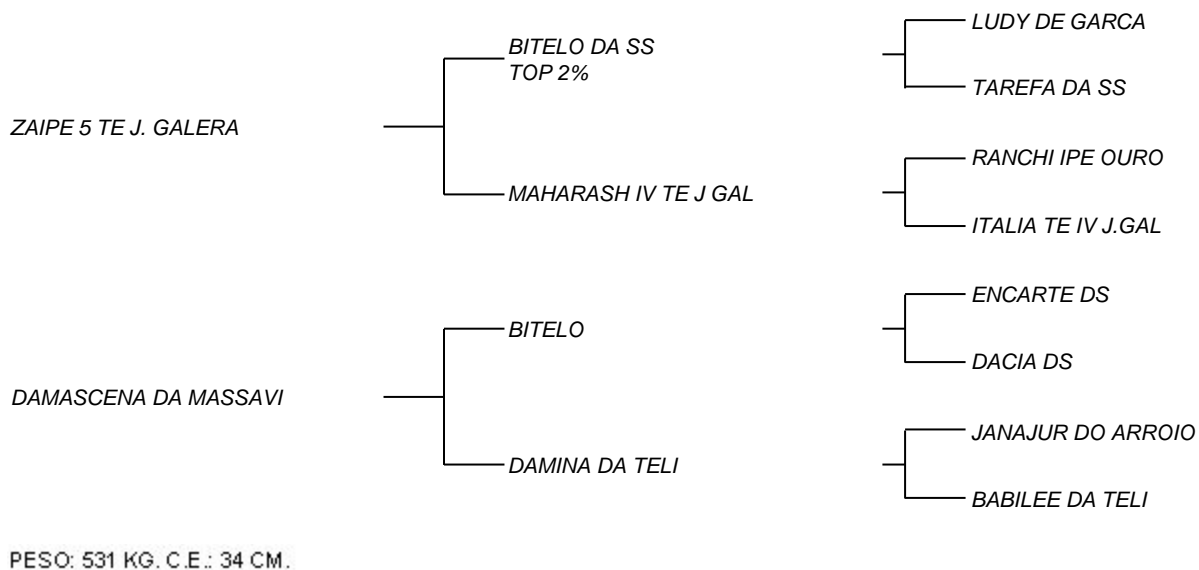



GASOMETRO DA MASSAVI

LOTE: 050

VENDEDOR(ES): AGROPECUARIA SANTA LUCIA

QTD.: 1

FAZENDA: AGROPECUARIA SANTA LUCIA

MSVI 2584 - NELORE - MACHO - NASC.:31/08/2016 - IDADE: 20 MS

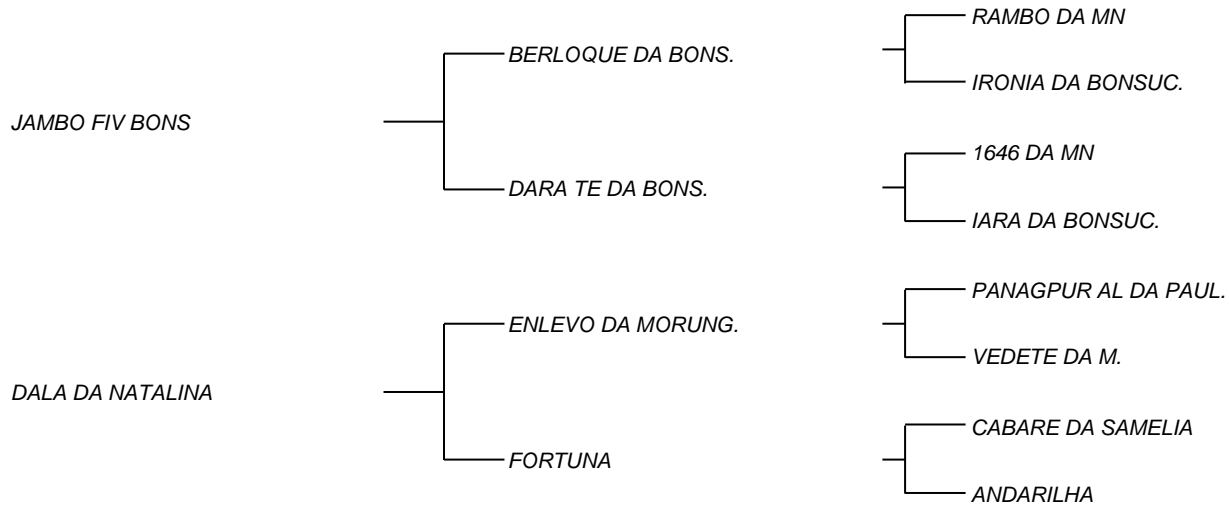

PESO: 554 KG. C.E.: 35 CM.

GIO DA MASSAVI

LOTE: 052

VENDEDOR(ES): AGROPECUARIA SANTA LUCIA

QTD.: 1

FAZENDA: AGROPECUARIA SANTA LUCIA

MSVI 2517 - NELORE - MACHO - NASC.:01/05/2016 - IDADE: 24 MS

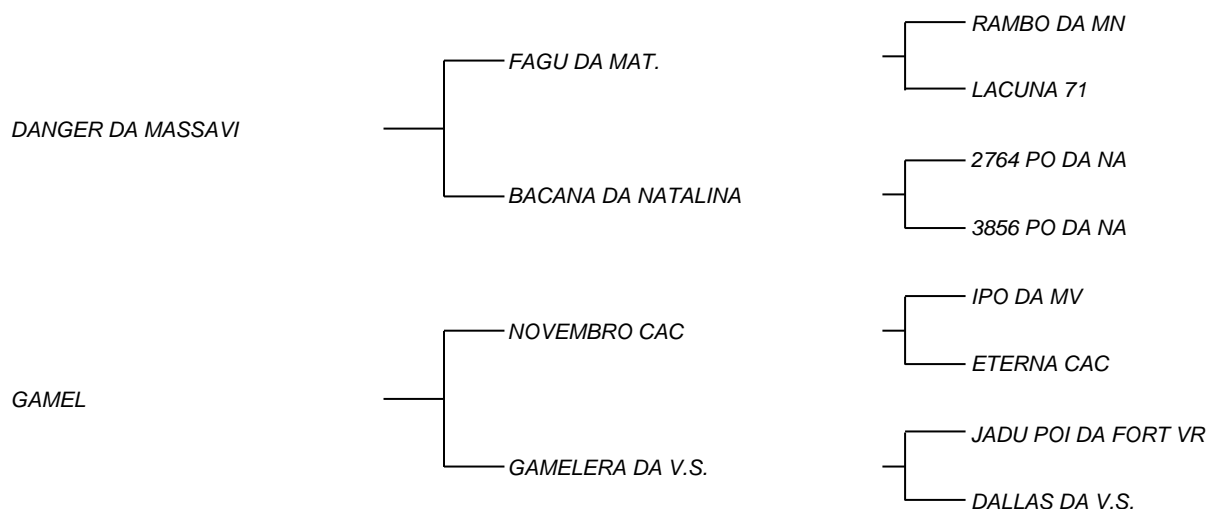

PESO: 563 KG. C.E.: 34 CM.



GITHO DA MASSAVI

LOTE: 053

VENDEDOR(ES): AGROPECUARIA SANTA LUCIA

QTD.: 1

FAZENDA: AGROPECUARIA SANTA LUCIA

MSVI 2585 - NELORE - MACHO - NASC.:11/08/2016 - IDADE: 21 MS

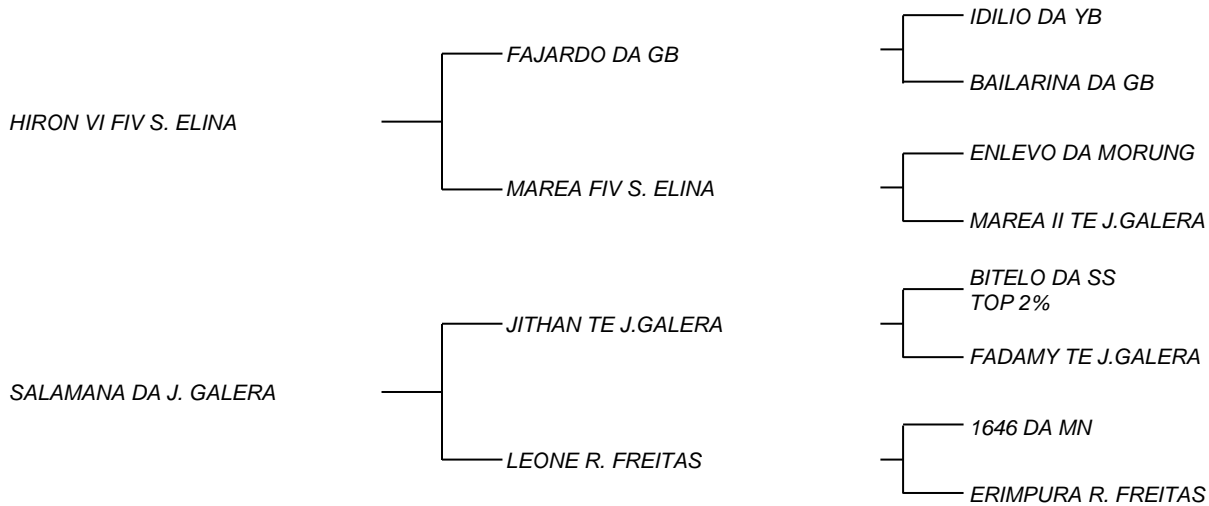

PESO: 533 KG. C.E.: 34 CM.

GOMINHO DA MASSAVI

LOTE: 054

VENDEDOR(ES): AGROPECUARIA SANTA LUCIA

QTD.: 1

FAZENDA: AGROPECUARIA SANTA LUCIA

MSVI 2704 - NELORE - MACHO - NASC.:12/10/2016 - IDADE: 19 MS

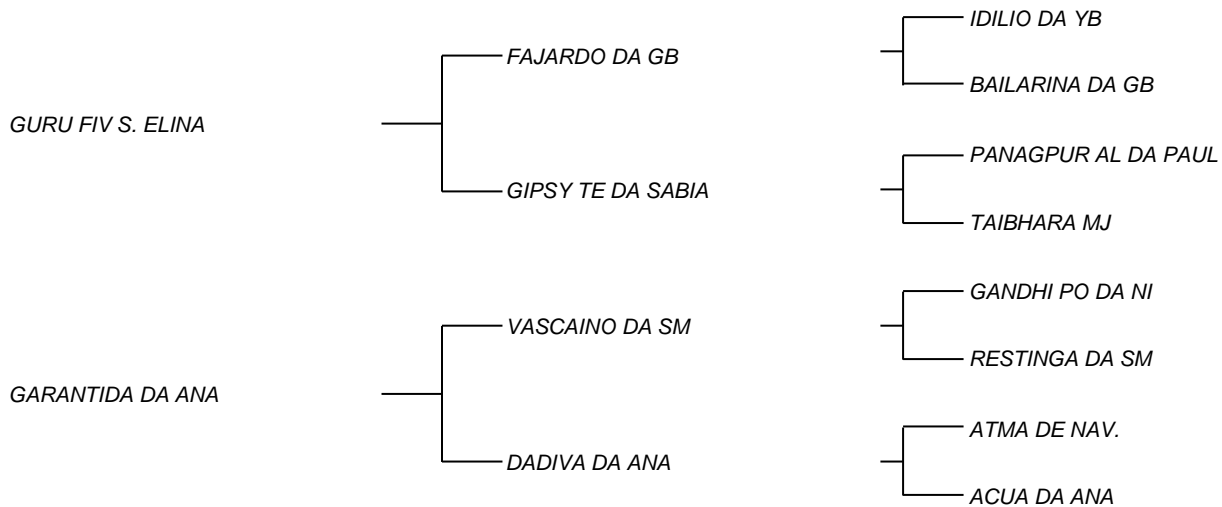

PESO: 515 KG. C.E.: 32 CM.



GOLFO DA MASSAVI

LOTE: 055

VENDEDOR(ES): AGROPECUARIA SANTA LUCIA

QTD.: 1

FAZENDA: AGROPECUARIA SANTA LUCIA

MSVI 2470 - NELORE - MACHO - NASC.:15/04/2016 - IDADE: 25 MS

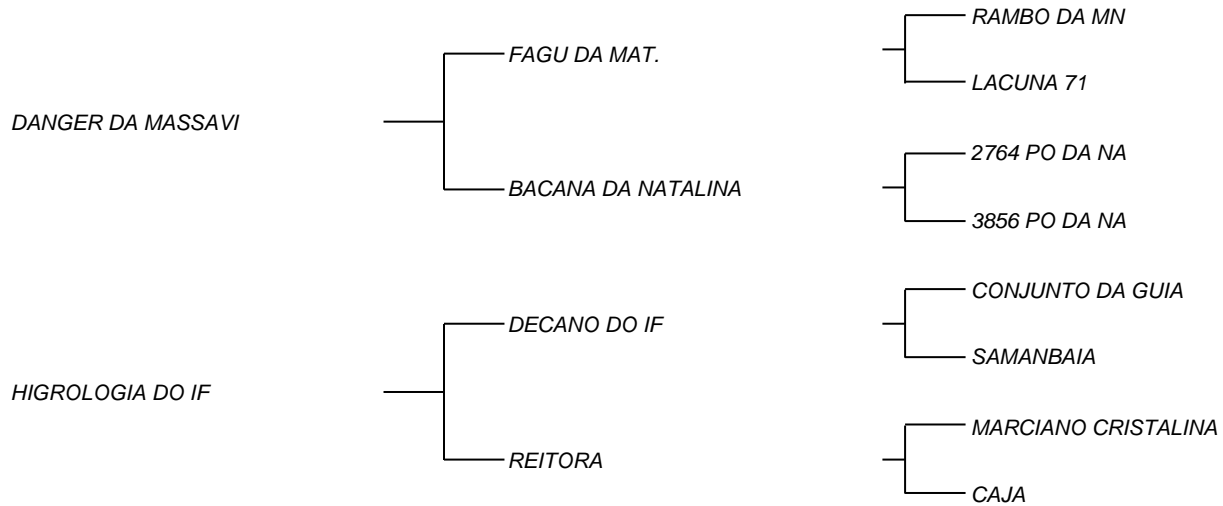

PESO: 529 KG. C.E.: 39 CM.

GODOFREDO DA MASSAVI

LOTE: 056

VENDEDOR(ES): AGROPECUARIA SANTA LUCIA

QTD.: 1

FAZENDA: AGROPECUARIA SANTA LUCIA

MSVI 2523 - NELORE - MACHO - NASC.:05/05/2016 - IDADE: 24 MS

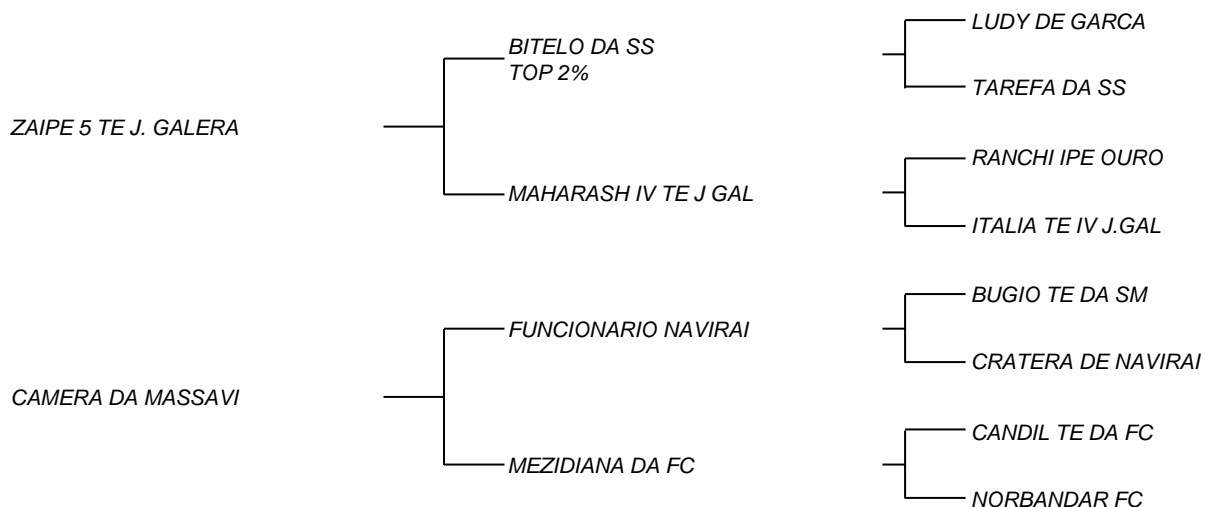

PESO: 505 KG. C.E.: 33 CM.



GALANTE DA MASSAVI

LOTE: 057

VENDEDOR(ES): AGROPECUARIA SANTA LUCIA

QTD.: 1

FAZENDA: AGROPECUARIA SANTA LUCIA

MSVI 2442 - NELORE - MACHO - NASC.:02/04/2016 - IDADE: 25 MS

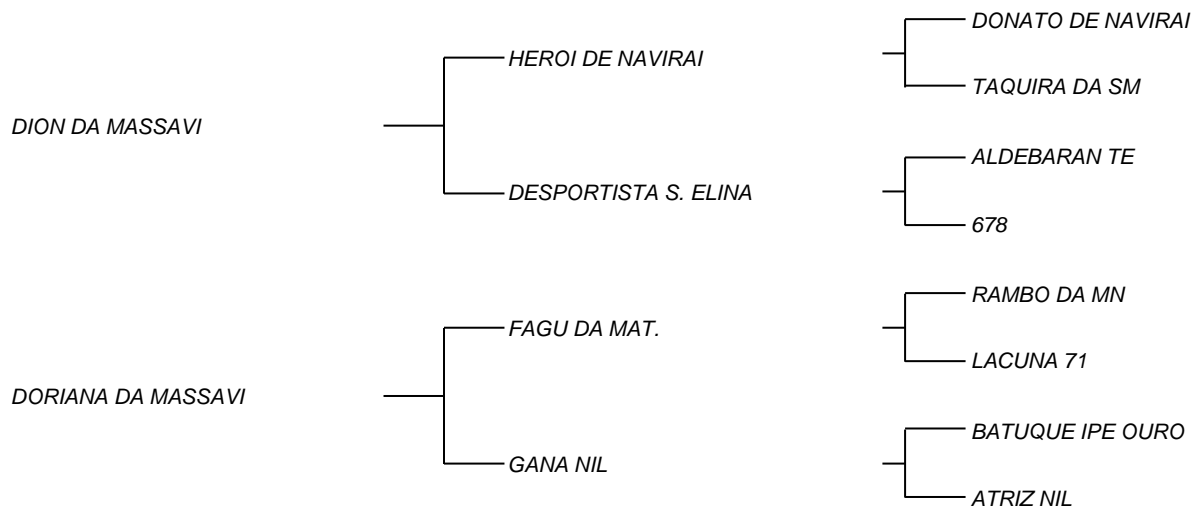

PESO: 546 KG. C.E.: 39 CM.

GUME DA MASSAVI

LOTE: 058

VENDEDOR(ES): AGROPECUARIA SANTA LUCIA

QTD.: 1

FAZENDA: AGROPECUARIA SANTA LUCIA

MSVI 2721 - NELORE - MACHO - NASC.:17/10/2016 - IDADE: 18 MS

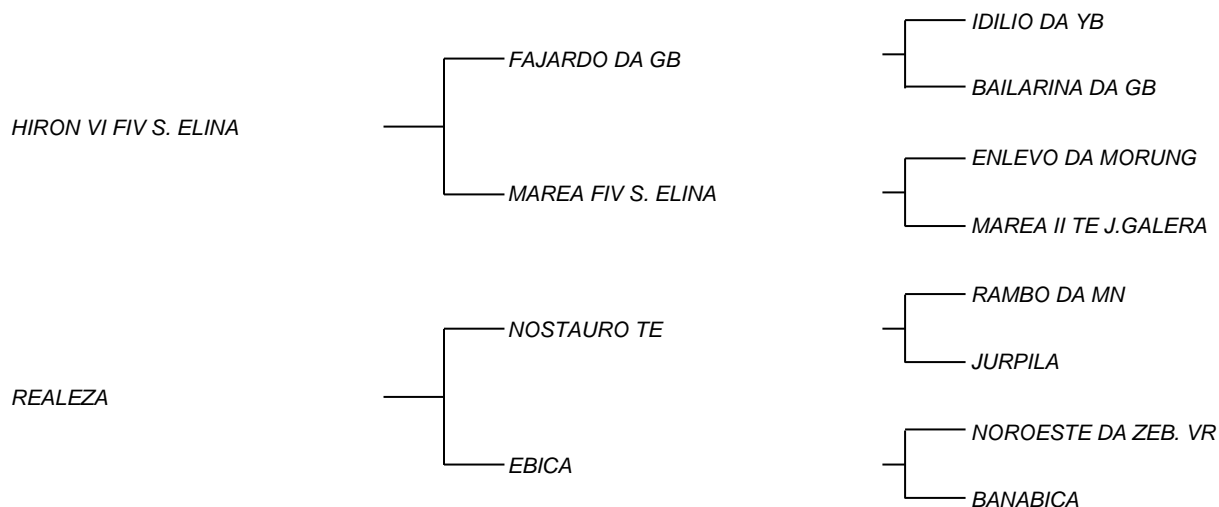

PESO: 488 KG. C.E.: 33 CM.



GUTHIERES DA MASSAVI

LOTE: 059

VENDEDOR(ES): AGROPECUARIA SANTA LUCIA

QTD.: 1

FAZENDA: AGROPECUARIA SANTA LUCIA

MSVI 2617 - NELORE - MACHO - NASC.:22/08/2016 - IDADE: 20 MS

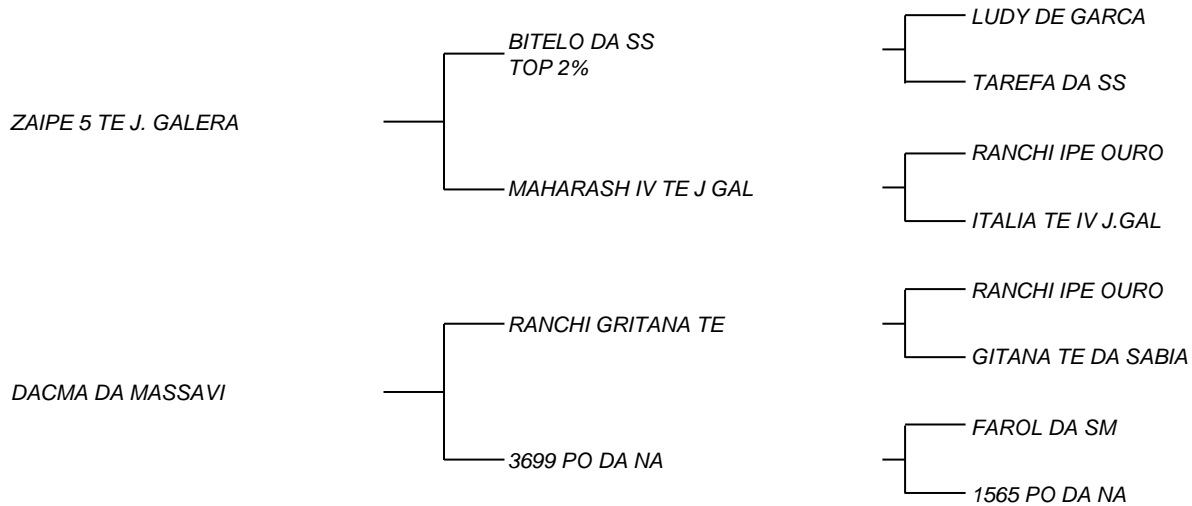

PESO: 535 KG. C.E.: 33 CM.

GUARULHOS DA MASSAVI

LOTE: 060

VENDEDOR(ES): AGROPECUARIA SANTA LUCIA

QTD.: 1

FAZENDA: AGROPECUARIA SANTA LUCIA

MSVI2686 - NELORE - MACHO - NASC.:05/10/2016 - IDADE: 19 MS

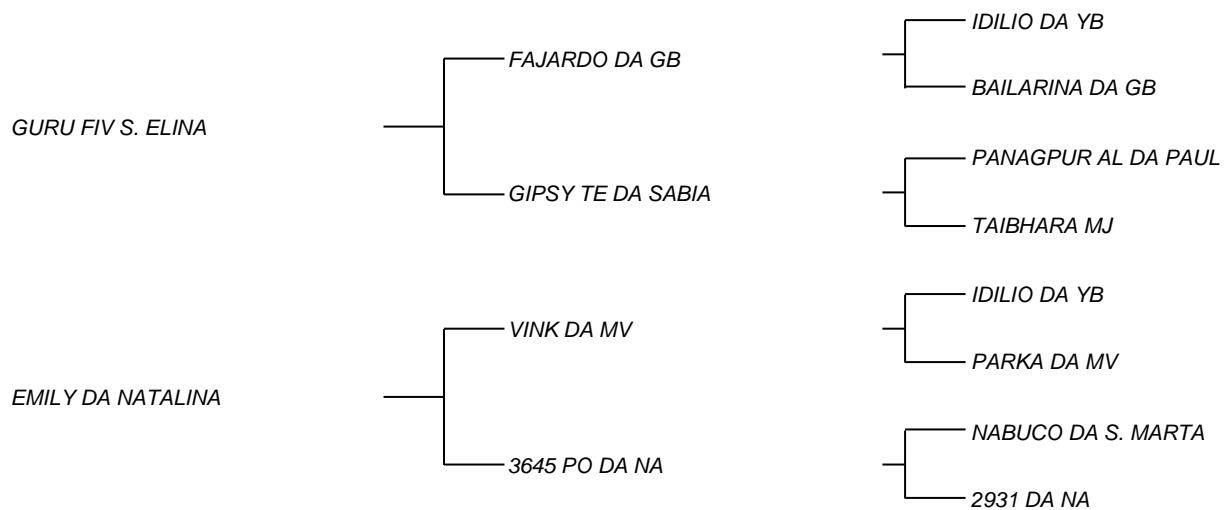

PESO: 480 KG. C.E.: 32 CM.



GAMACHO DA MASSAVI

LOTE: 061

VENDEDOR(ES): AGROPECUARIA SANTA LUCIA

QTD.: 1

FAZENDA: AGROPECUARIA SANTA LUCIA

MSVI 2514 - NELORE - MACHO - NASC.:30/04/2016 - IDADE: 24 MS

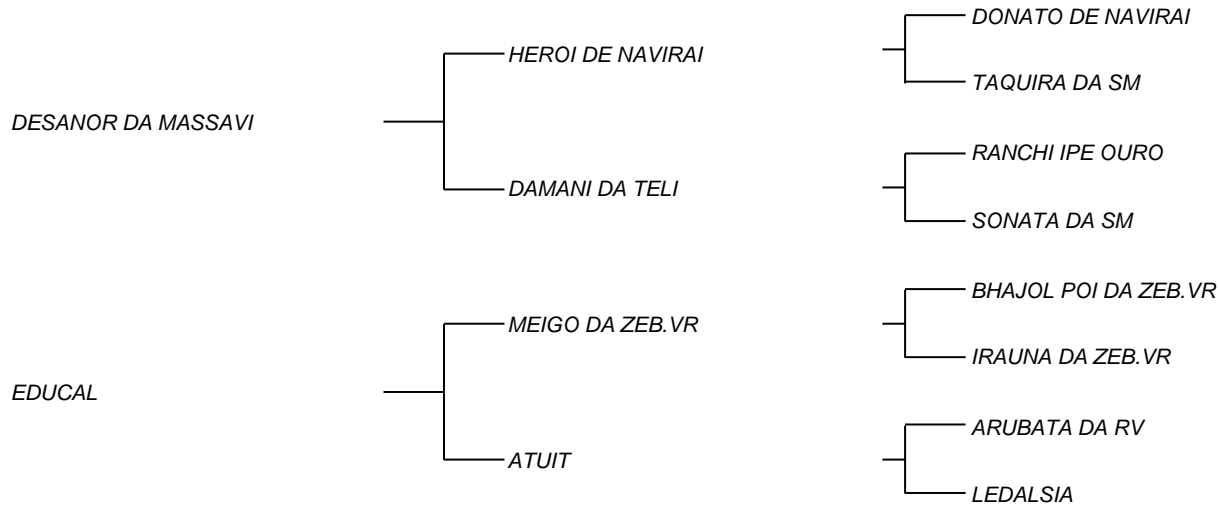

PESO: 524 KG. C.E.: 33 CM.

GUIMARAES DA MASSAVI

LOTE: 062

VENDEDOR(ES): AGROPECUARIA SANTA LUCIA

QTD.: 1

FAZENDA: AGROPECUARIA SANTA LUCIA

MSVI 2596 - NELORE - MACHO - NASC.:15/08/2016 - IDADE: 21 MS

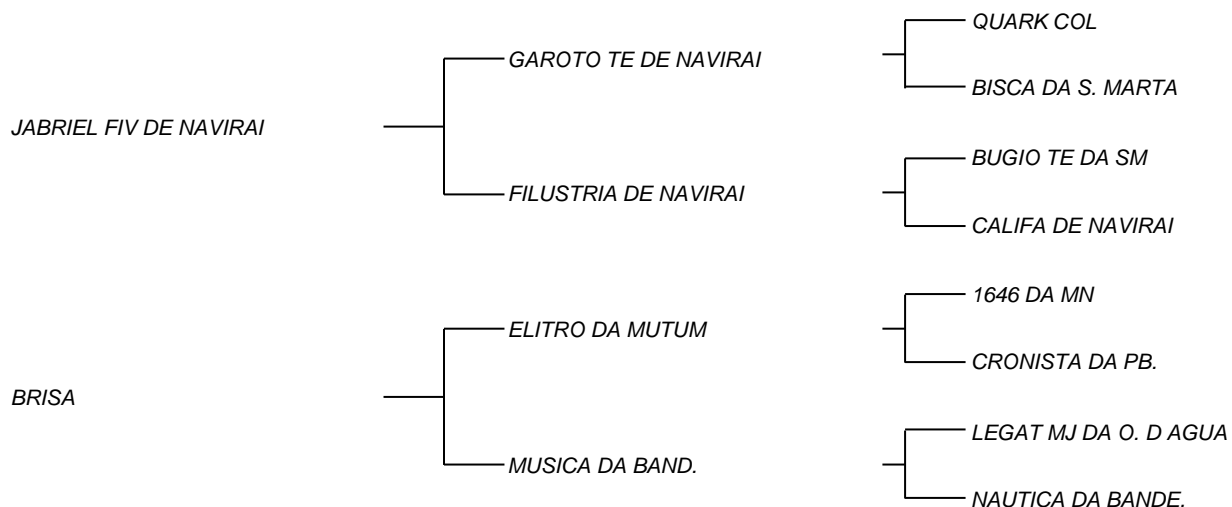

PESO: 477 KG. C.E.: 32 CM.



GEOMETRICO DA MASSAVI

LOTE: 063

VENDEDOR(ES): AGROPECUARIA SANTA LUCIA

QTD.: 1

FAZENDA: AGROPECUARIA SANTA LUCIA

MSVI 2675 - NELORE - MACHO - NASC.:01/10/2016 - IDADE: 19 MS

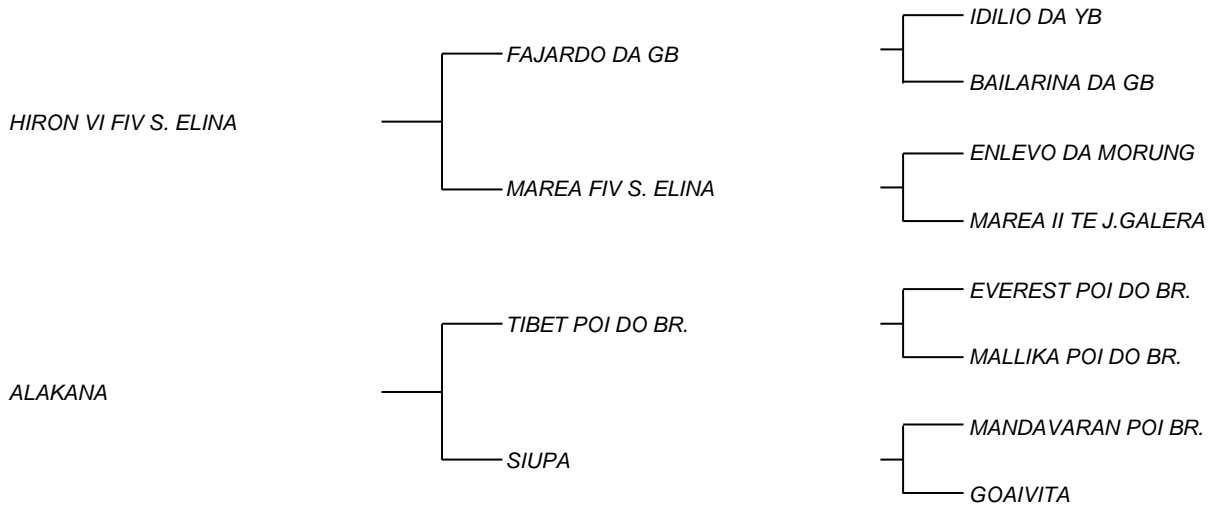

PESO: 470 KG. C.E.: 33 CM.

GRANULOSO DA MASSAVI

LOTE: 064

VENDEDOR(ES): AGROPECUARIA SANTA LUCIA

QTD.: 1

FAZENDA: AGROPECUARIA SANTA LUCIA

MSVI 2754 - NELORE - MACHO - NASC.:31/10/2016 - IDADE: 18 MS

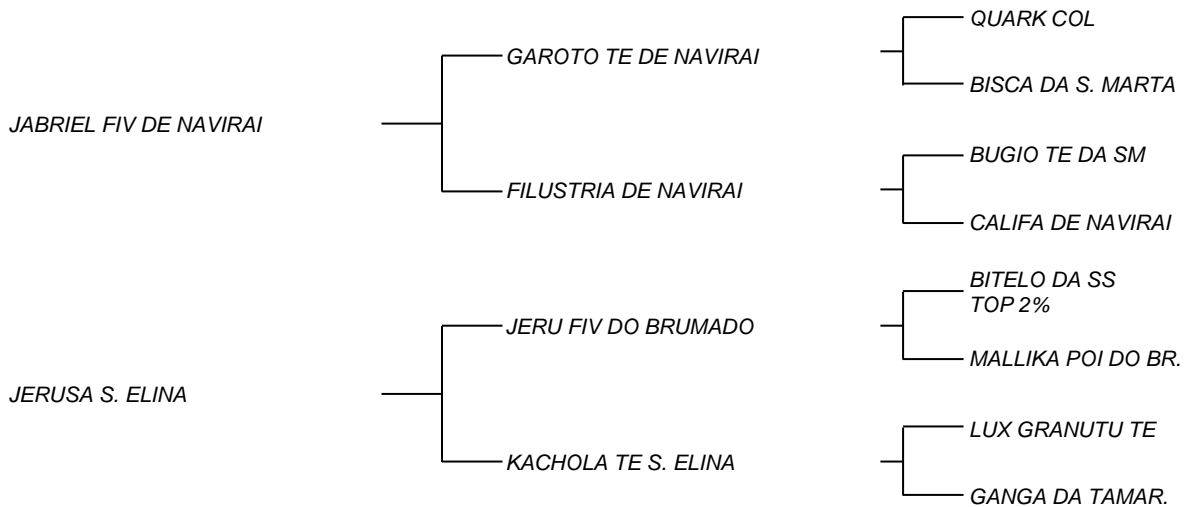

PESO: 472 KG. C.E.: 33 CM.



GALGO DA MASSAVI

LOTE: 065

VENDEDOR(ES): AGROPECUARIA SANTA LUCIA

QTD.: 1

FAZENDA: AGROPECUARIA SANTA LUCIA

MSVI 2572 - NELORE - MACHO - NASC.:05/08/2016 - IDADE: 21 MS

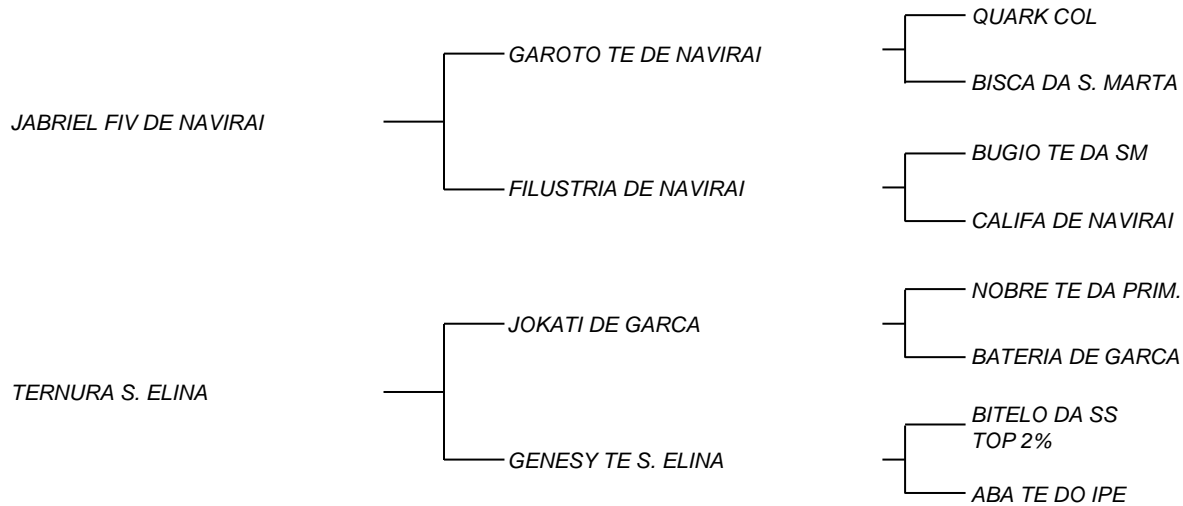

PESO: 485 KG. C.E.: 32 CM.

GASPARINO DA MASSAVI

LOTE: 066

VENDEDOR(ES): AGROPECUARIA SANTA LUCIA

QTD.: 1

FAZENDA: AGROPECUARIA SANTA LUCIA

MSVI 2656 - NELORE - MACHO - NASC.:23/09/2016 - IDADE: 19 MS

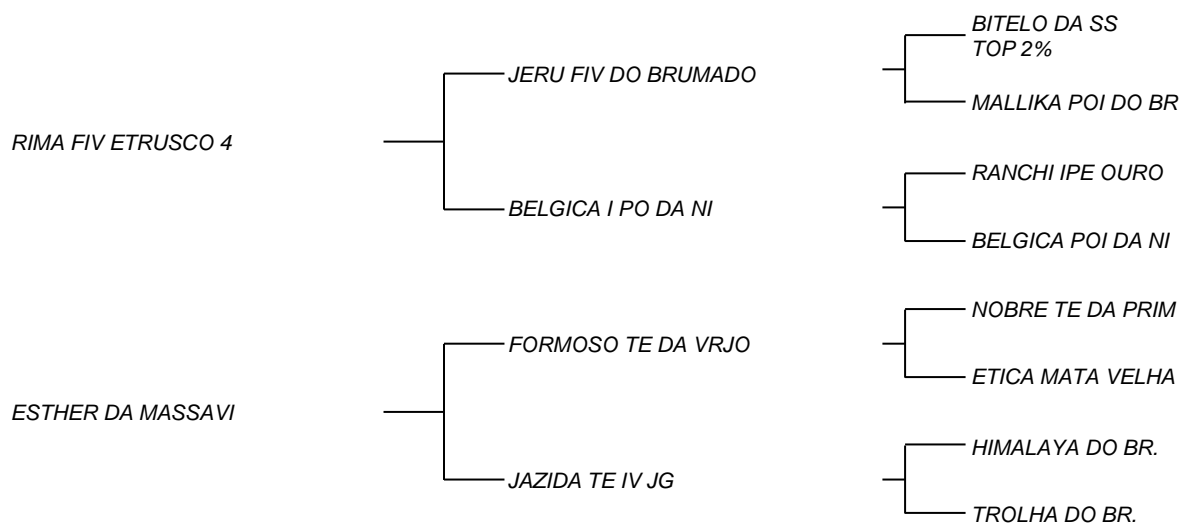

PESO: 470 KG. C.E.: 32 CM.



GIRASSOL DA MASSAVI

LOTE: 067

VENDEDOR(ES): AGROPECUARIA SANTA LUCIA

QTD.: 1

FAZENDA: AGROPECUARIA SANTA LUCIA

MSVI 2566 - NELORE - MACHO - NASC.:27/07/2016 - IDADE: 21 MS

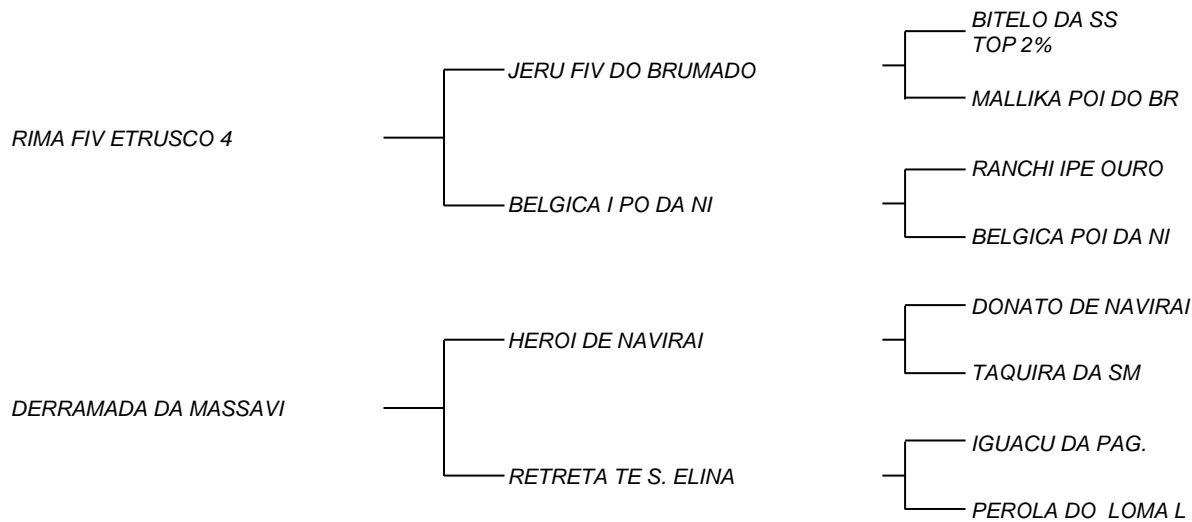

PESO: 514 KG. C.E.: 34 CM.

GOLD DA MASSAVI

LOTE: 068

VENDEDOR(ES): AGROPECUARIA SANTA LUCIA

QTD.: 1

FAZENDA: AGROPECUARIA SANTA LUCIA

MSVI 2665 - NELORE - MACHO - NASC.:25/09/2016 - IDADE: 19 MS

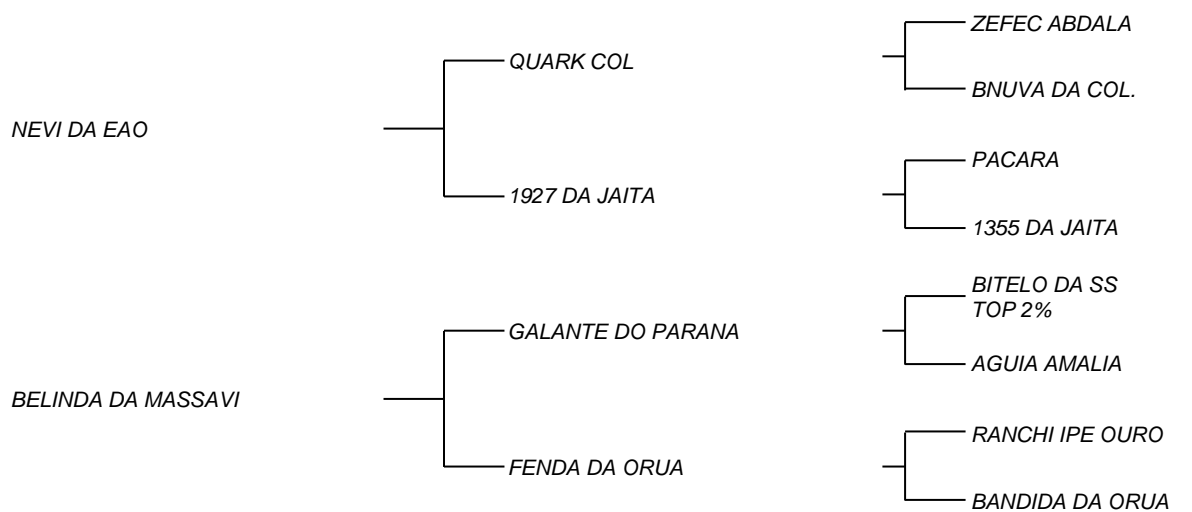

PESO: 474 KG. C.E.: 35 CM.



GALAXY DA MASSAVI

LOTE: 069

VENDEDOR(ES): AGROPECUARIA SANTA LUCIA

QTD.: 1

FAZENDA: AGROPECUARIA SANTA LUCIA

MSVI 2582 - NELORE - MACHO - NASC.:09/08/2016 - IDADE: 21 MS

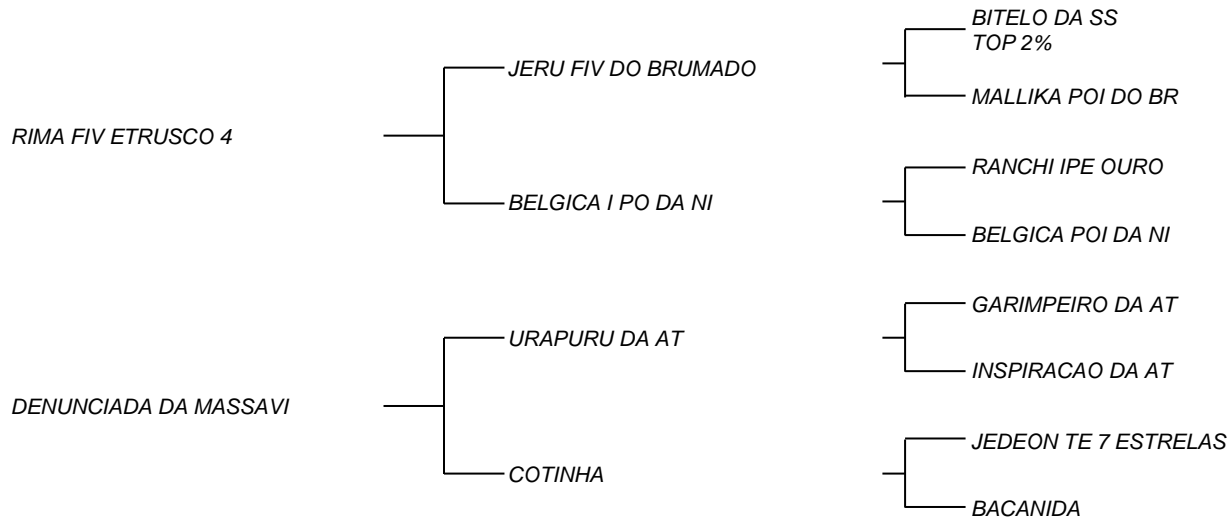

PESO: 529 KG. C.E.: 32 CM.

GRANDIL DA MASSAVI

LOTE: 070

VENDEDOR(ES): AGROPECUARIA SANTA LUCIA

QTD.: 1

MSVI 2664 - NELORE - MACHO - NASC.:24/09/2016 - IDADE: 19 MS

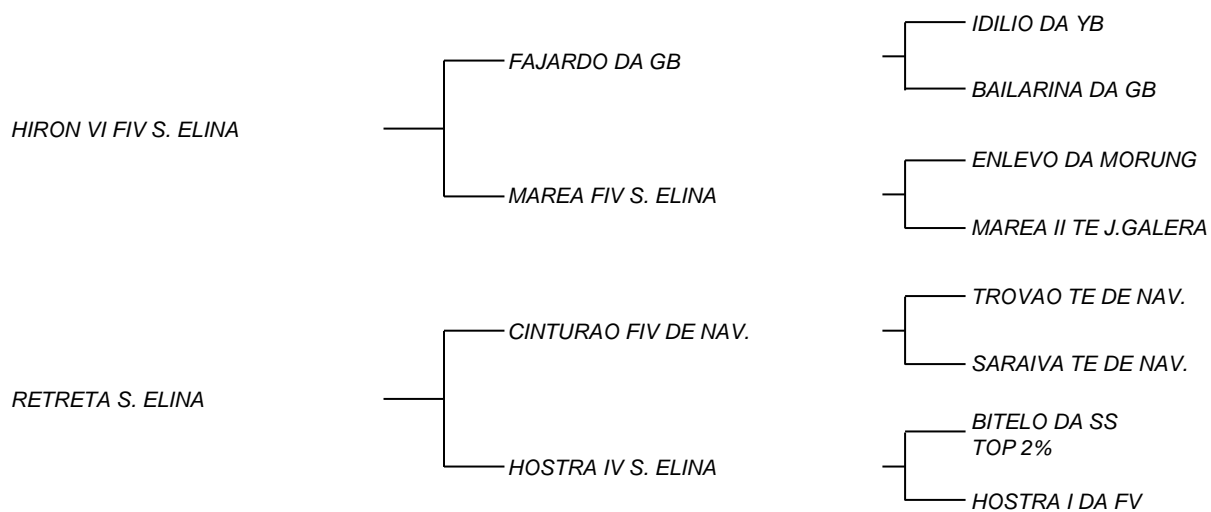

PESO: 475 KG. C.E.: 34 CM.



GRANDOTE DA MASSAVI

LOTE: 071

VENDEDOR(ES): AGROPECUARIA SANTA LUCIA

QTD.: 1

FAZENDA: AGROPECUARIA SANTA LUCIA

MSVI 2638 - NELORE - MACHO - NASC.:13/09/2016 - IDADE: 20 MS

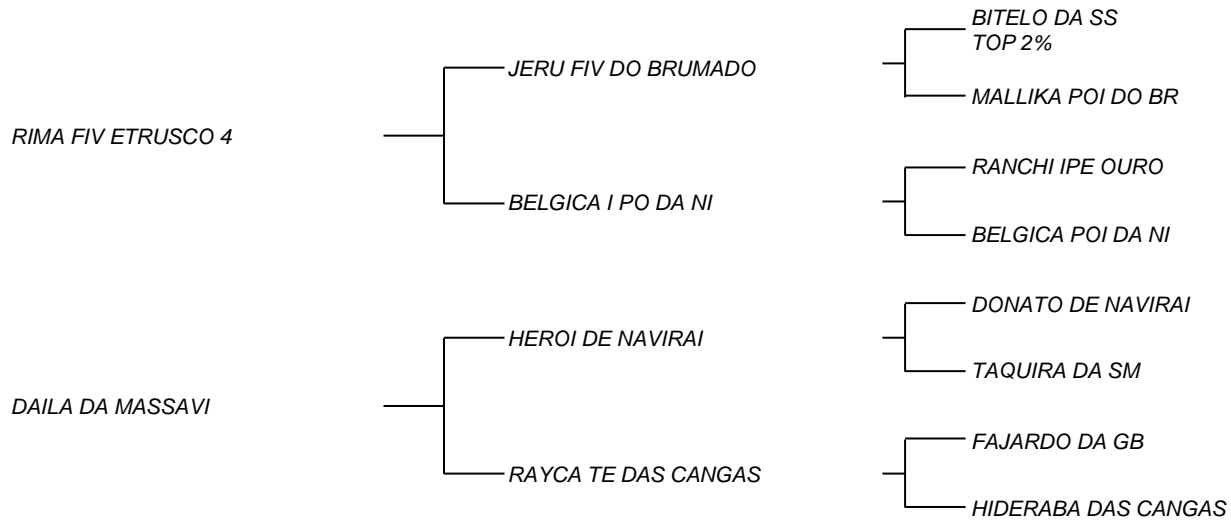

PESO: 470 KG. C.E.: 31 CM.

GUARDA COSTA DA MASSAVI

LOTE: 072

VENDEDOR(ES): AGROPECUARIA SANTA LUCIA

QTD.: 1

FAZENDA: AGROPECUARIA SANTA LUCIA

MSVI 237 - NELORE - MACHO - NASC.:09/02/2016 - IDADE: 27 MS

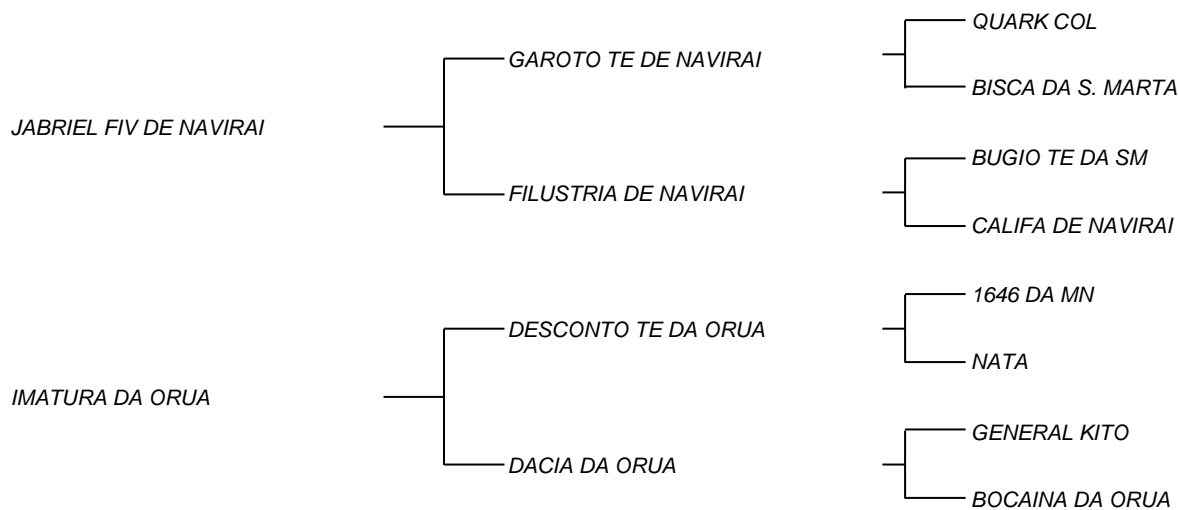

PESO: 616 KG. C.E.: 39,5 CM.



GULOSO DA MASSAVI

LOTE: 073

VENDEDOR(ES): AGROPECUARIA SANTA LUCIA

QTD.: 1

FAZENDA: AGROPECUARIA SANTA LUCIA

MSVI 2551 - NELORE - MACHO - NASC.:30/05/2016 - IDADE: 23 MS



PESO: 623 KG. C.E.: 40 CM.

GUETO DA MASSAVI

LOTE: 074

VENDEDOR(ES): AGROPECUARIA SANTA LUCIA

QTD.: 1

FAZENDA: AGROPECUARIA SANTA LUCIA

MSVI 2417 - NELORE - MACHO - NASC.:17/03/2016 - IDADE: 26 MS



PESO: 650 KG. C.E.: 40 CM.



FLUIDO DA MASSAVI

LOTE: 075

VENDEDOR(ES): AGROPECUARIA SANTA LUCIA

QTD.: 1

FAZENDA: AGROPECUARIA SANTA LUCIA

MSVI 2256 - NELORE - MACHO - NASC.:22/12/2016 - IDADE: 16 MS

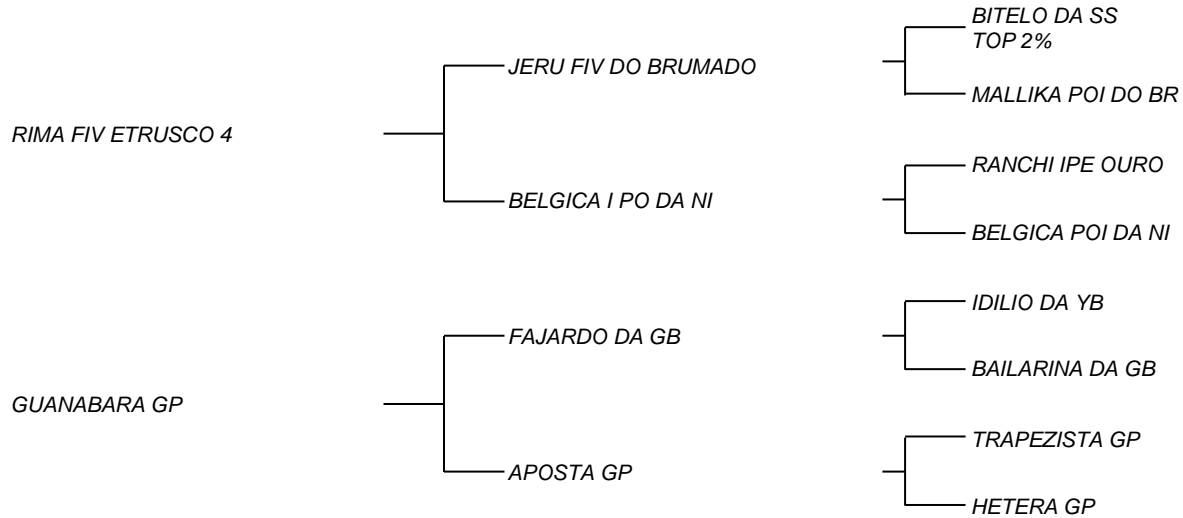

PESO: 550 KG. C.E.: 38,5 CM.

GALAO DA MASSAVI

LOTE: 076

VENDEDOR(ES): AGROPECUARIA SANTA LUCIA

QTD.: 1

FAZENDA: AGROPECUARIA SANTA LUCIA

MSVI 2429 - NELORE - MACHO - NASC.:21/03/2016 - IDADE: 25 MS

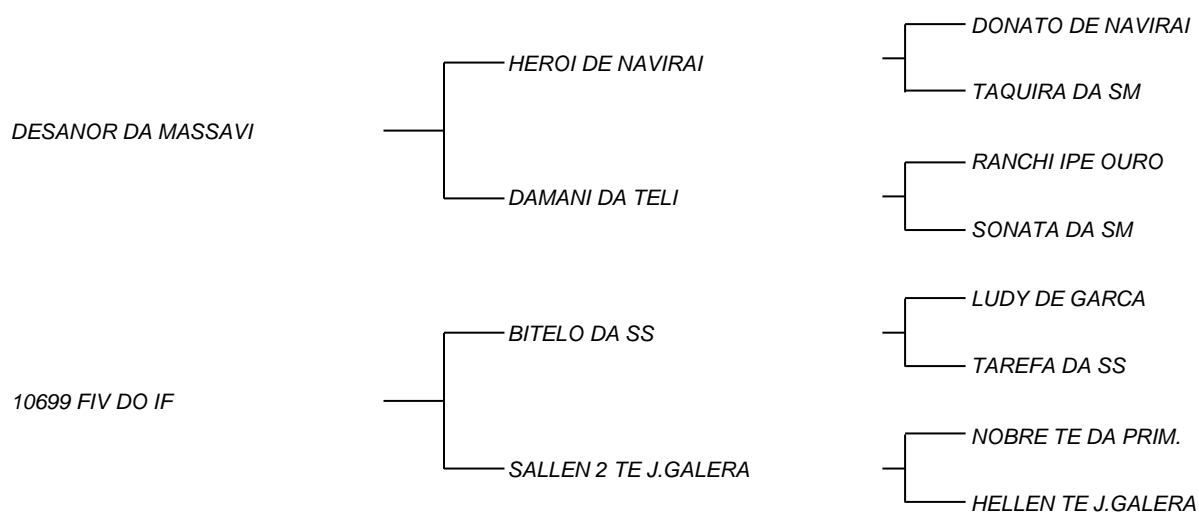

PESO: 607 KG. C.E.: 40 CM.



GIDEAO DA MASSAVI

LOTE: 077

VENDEDOR(ES): AGROPECUARIA SANTA LUCIA

QTD.: 1

FAZENDA: AGROPECUARIA SANTA LUCIA

MSVI 2529 - NELORE - MACHO - NASC.:11/05/2016 - IDADE: 24 MS

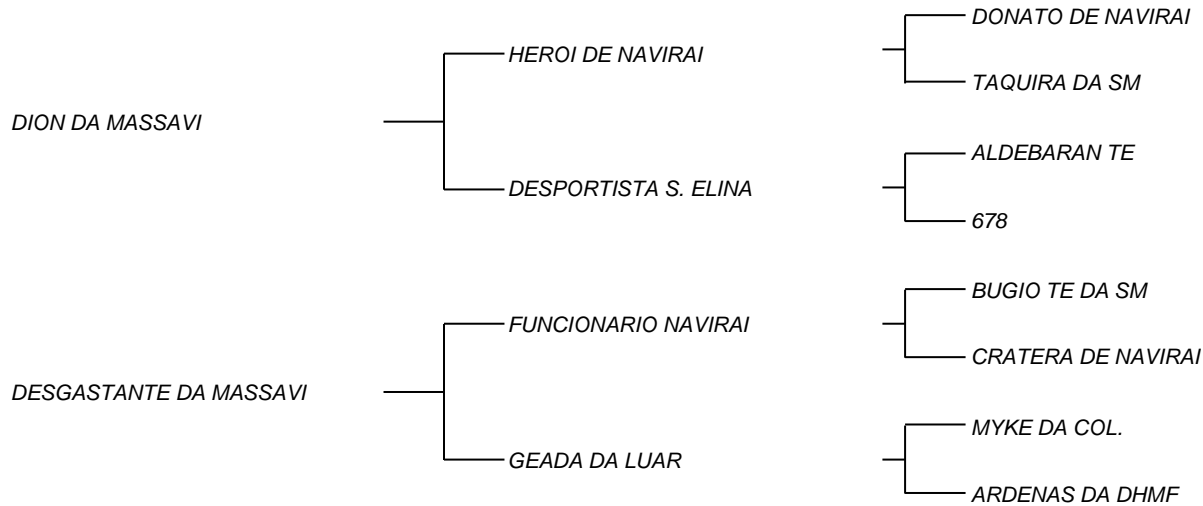

PESO: 581 KG. C.E.: 40 CM.

GUINCHO DA MASSAVI

LOTE: 078

VENDEDOR(ES): AGROPECUARIA SANTA LUCIA

QTD.: 1

FAZENDA: AGROPECUARIA SANTA LUCIA

MSVI 2292 - NELORE - MACHO - NASC.:09/01/2016 - IDADE: 28 MS

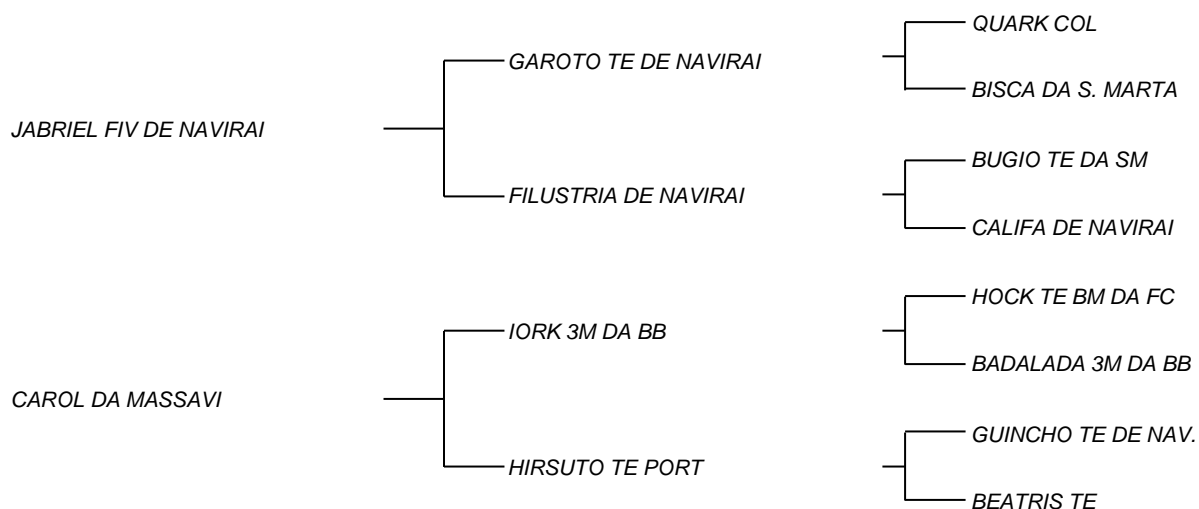

PESO: 530 KG. C.E.: 36 CM.



GUNY DA MASSAVI

LOTE: 079

VENDEDOR(ES): AGROPECUARIA SANTA LUCIA

QTD.: 1

FAZENDA: AGROPECUARIA SANTA LUCIA

MSVI 2490 - NELORE - MACHO - NASC.:21/04/2016 - IDADE: 24 MS

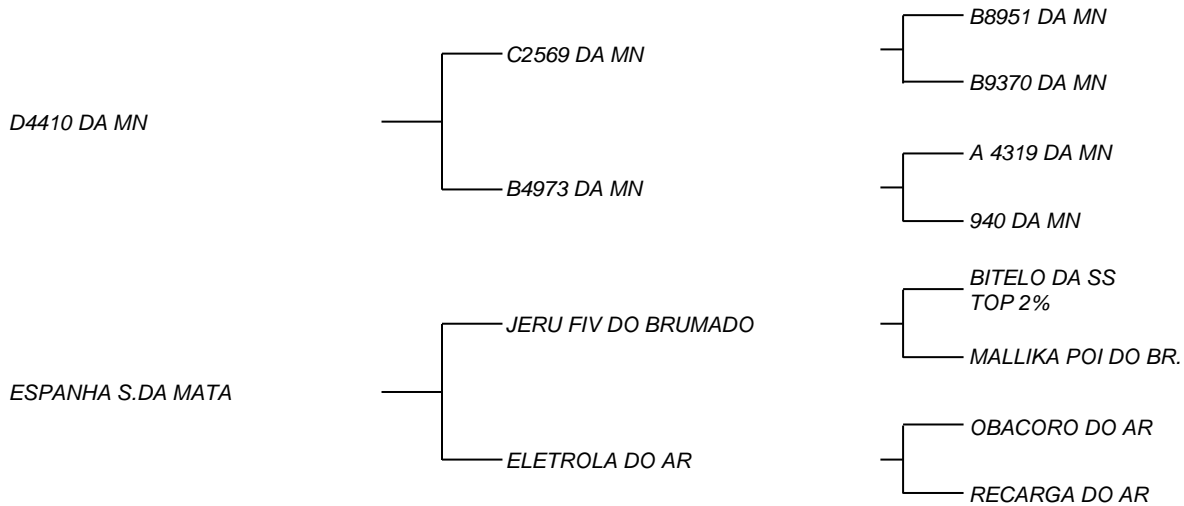

PESO: 580 KG. C.E.: 40,5 CM.

GIMENNA DA MASSAVI

LOTE: 080

VENDEDOR(ES): AGROPECUARIA SANTA LUCIA

QTD.: 1

FAZENDA: AGROPECUARIA SANTA LUCIA

MSVI 2422 - NELORE - MACHO - NASC.:17/03/2016 - IDADE: 26 MS

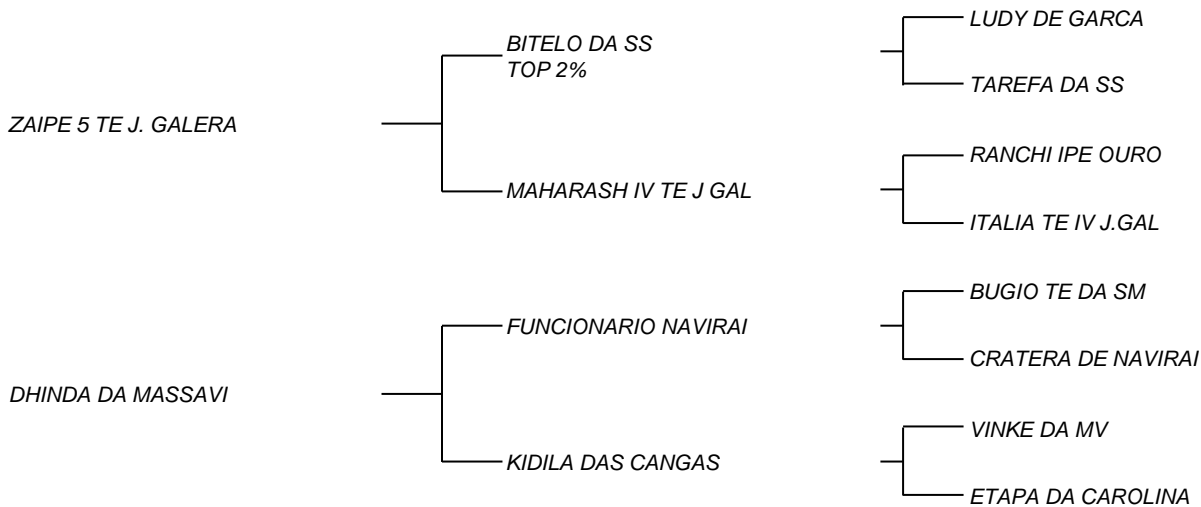

PESO: 550 KG. C.E.: 38 CM.



GHITO DA MASSAVI

LOTE: 081

VENDEDOR(ES): AGROPECUARIA SANTA LUCIA

QTD.: 1

FAZENDA: AGROPECUARIA SANTA LUCIA

MSVI 2555 - NELORE - MACHO - NASC.:02/06/2016 - IDADE: 23 MS

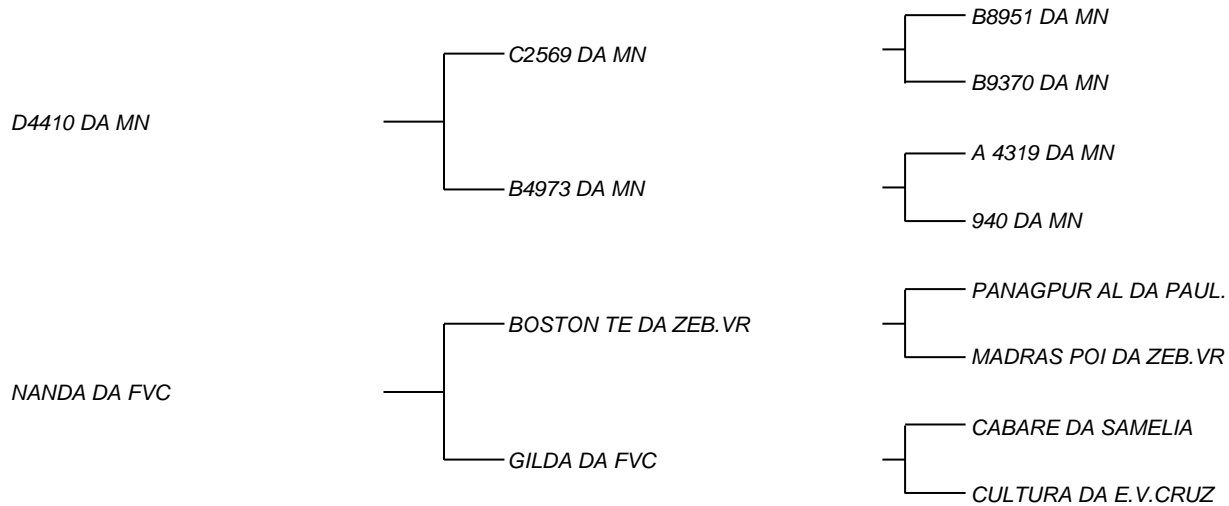

PESO: 513 KG. C.E.: 37 CM.

GATUNO DA MASSAVI

LOTE: 082

VENDEDOR(ES): AGROPECUARIA SANTA LUCIA

QTD.: 1

FAZENDA: AGROPECUARIA SANTA LUCIA

MSVI 2499 - NELORE - MACHO - NASC.:23/04/2016 - IDADE: 24 MS

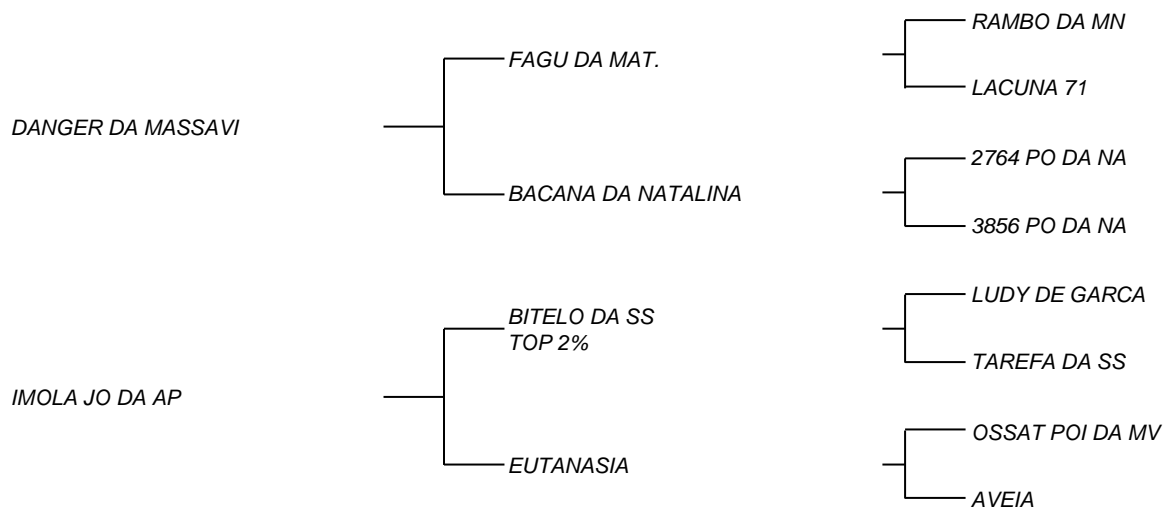

PESO: 516 KG. C.E.: 35,5 CM.



GOTICO DA MASSAVI

LOTE: 083

VENDEDOR(ES): AGROPECUARIA SANTA LUCIA

QTD.: 1

FAZENDA: AGROPECUARIA SANTA LUCIA

MSVI 2573 - NELORE - MACHO - NASC.:05/08/2016 - IDADE: 21 MS

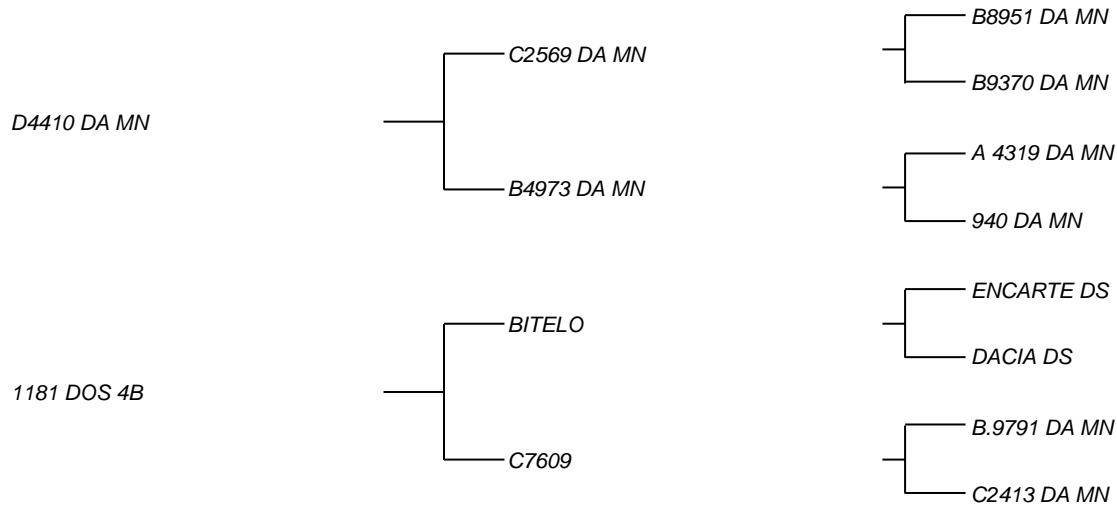

PESO: 497 KG. C.E.: 36 CM.

GRANITO DA MASSAVI

LOTE: 084

VENDEDOR(ES): AGROPECUARIA SANTA LUCIA

QTD.: 1

FAZENDA: AGROPECUARIA SANTA LUCIA

MSVI 2632 - NELORE - MACHO - NASC.:07/09/2016 - IDADE: 20 MS

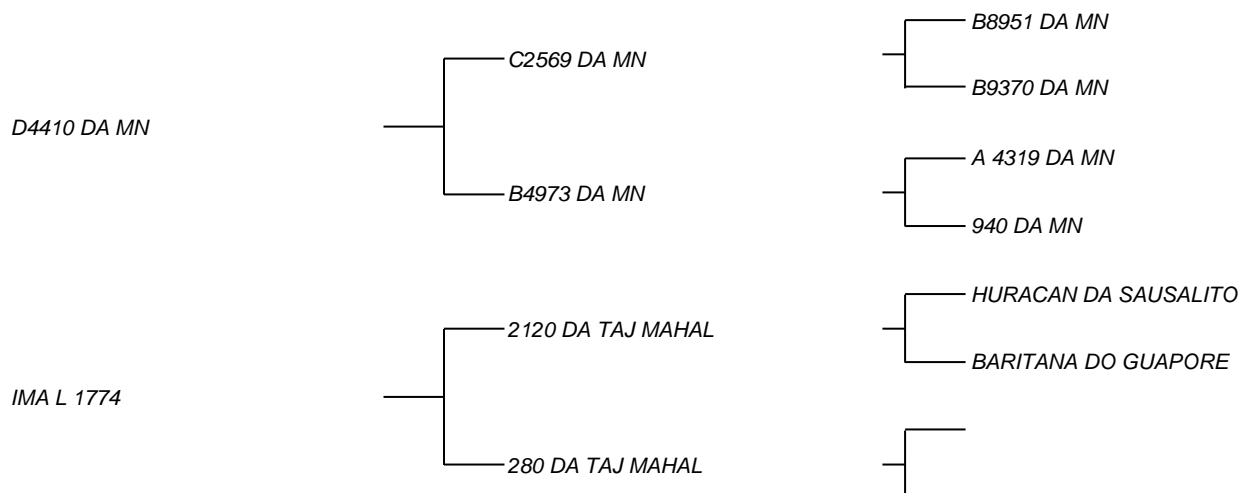

PESO: 482 KG. C.E.: 35 CM.



GASPARETO DA MASSAVI

LOTE: 085

VENDEDOR(ES): AGROPECUARIA SANTA LUCIA

QTD.: 1

FAZENDA: AGROPECUARIA SANTA LUCIA

MSVI 2641 - NELORE - MACHO - NASC.:15/09/2016 - IDADE: 19 MS

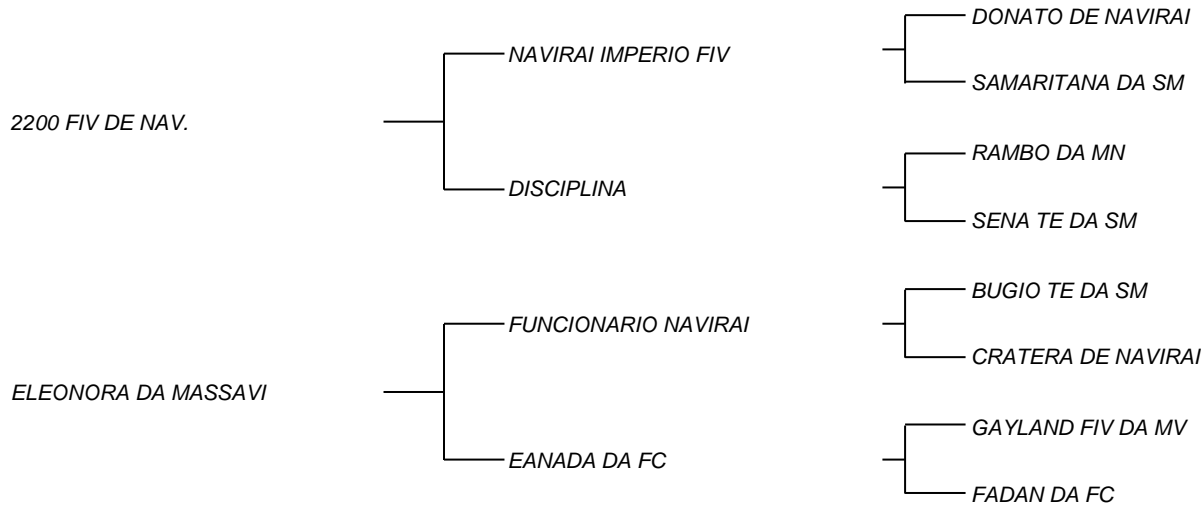

PESO: 464 KG. C.E.: 32 CM.

GASPAROTO DA MASSAVI

LOTE: 086

VENDEDOR(ES): AGROPECUARIA SANTA LUCIA

QTD.: 1

FAZENDA: AGROPECUARIA SANTA LUCIA

MSVI 2655 - NELORE - MACHO - NASC.:22/09/2016 - IDADE: 19 MS

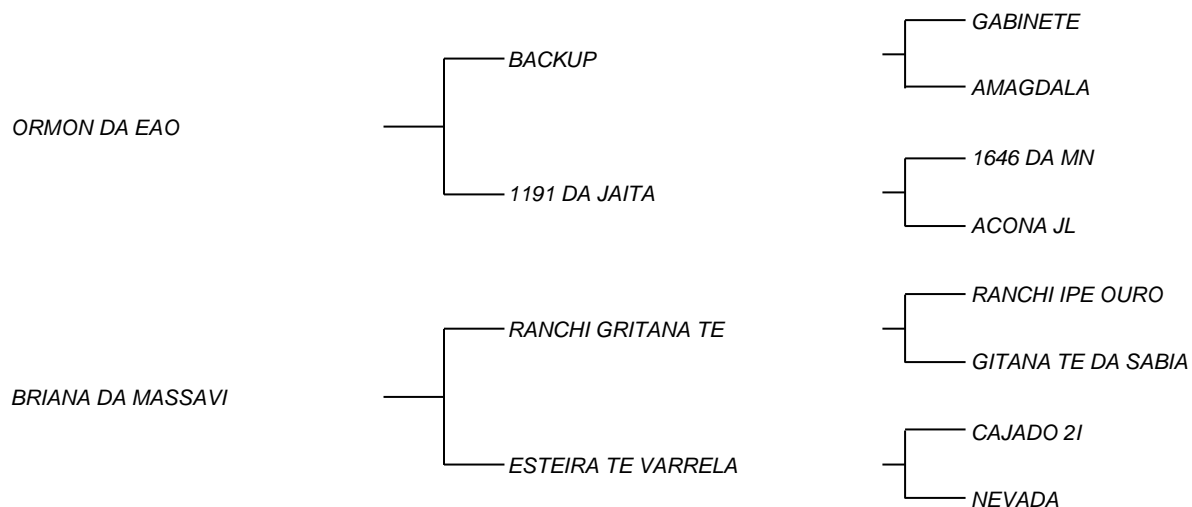

PESO: 500 KG. C.E.: 34 CM.



GOVERNADOR DA MASSAVI

LOTE: 087

VENDEDOR(ES): AGROPECUARIA SANTA LUCIA

QTD.: 1

FAZENDA: AGROPECUARIA SANTA LUCIA

MSVI 2636 - NELORE - MACHO - NASC.:01/09/2016 - IDADE: 20 MS

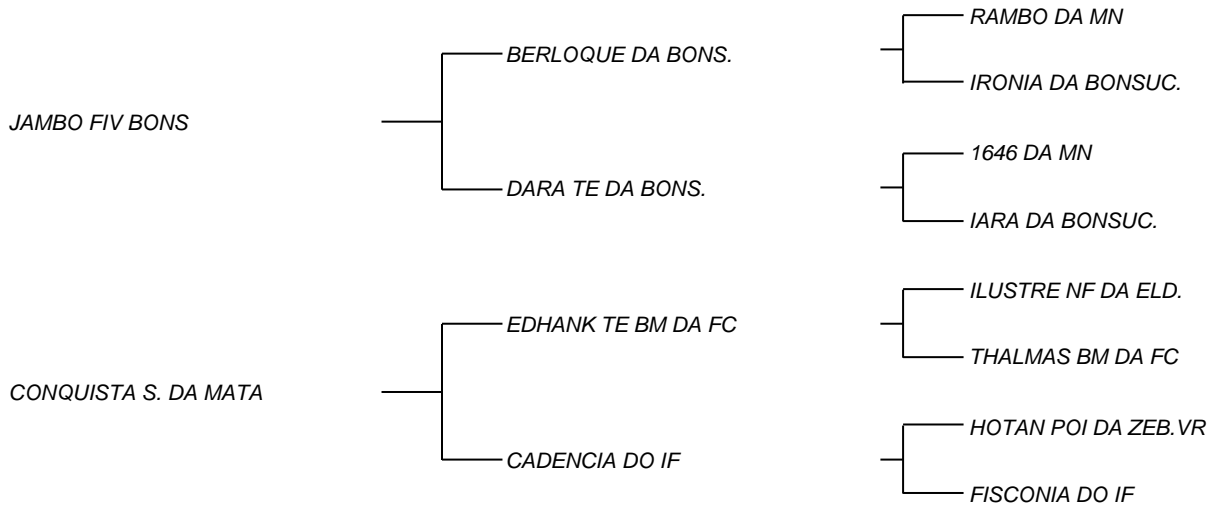

PESO: 470 KG. C.E.: 34,5 CM.

GRACIOSO DA MASSAVI

LOTE: 088

VENDEDOR(ES): AGROPECUARIA SANTA LUCIA

QTD.: 1

FAZENDA: AGROPECUARIA SANTA LUCIA

MSVI 2630 - NELORE - MACHO - NASC.:05/09/2016 - IDADE: 20 MS

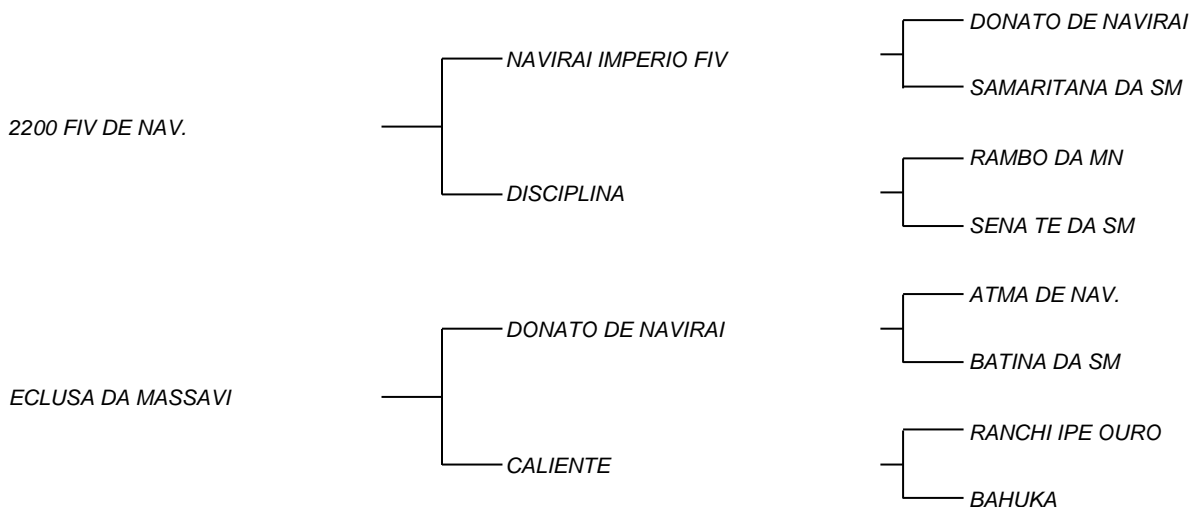

PESO: 419 KG. C.E.: 33,5 CM.



GIBAO DA MASSAVI

LOTE: 089

VENDEDOR(ES): AGROPECUARIA SANTA LUCIA

QTD.: 1

FAZENDA: AGROPECUARIA SANTA LUCIA

MSVI 2604 - NELORE - MACHO - NASC.:17/08/2016 - IDADE: 20 MS

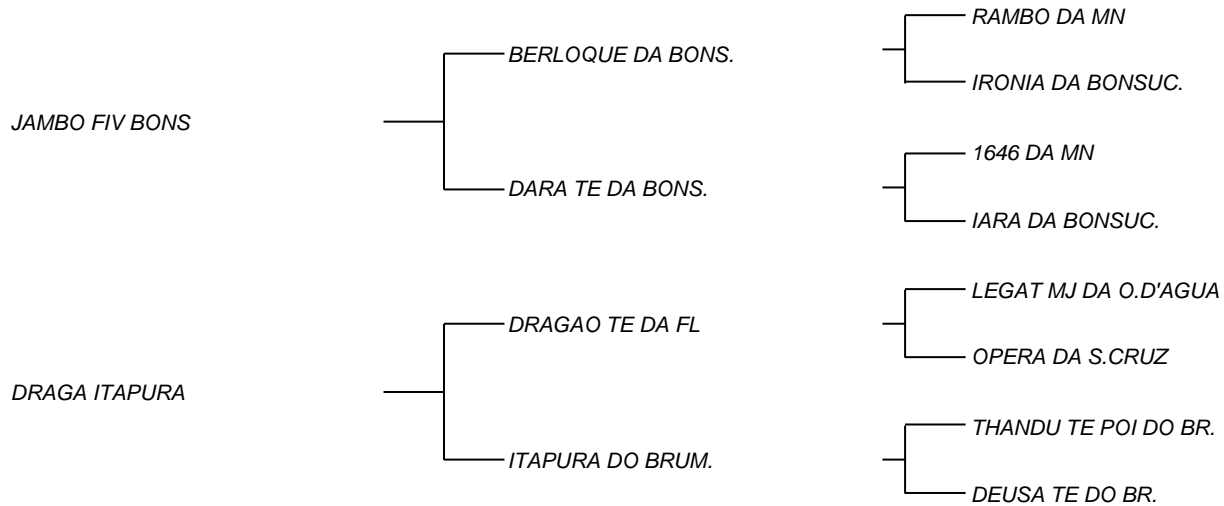

PESO: 485 KG. C.E.: 37 CM.

FOREVER DA MASSAVI

LOTE: 091

VENDEDOR(ES): AGROPECUARIA SANTA LUCIA

QTD.: 1

FAZENDA: AGROPECUARIA SANTA LUCIA

MSVI 2202 - NELORE - MACHO - NASC.:30/10/2015 - IDADE: 30 MS

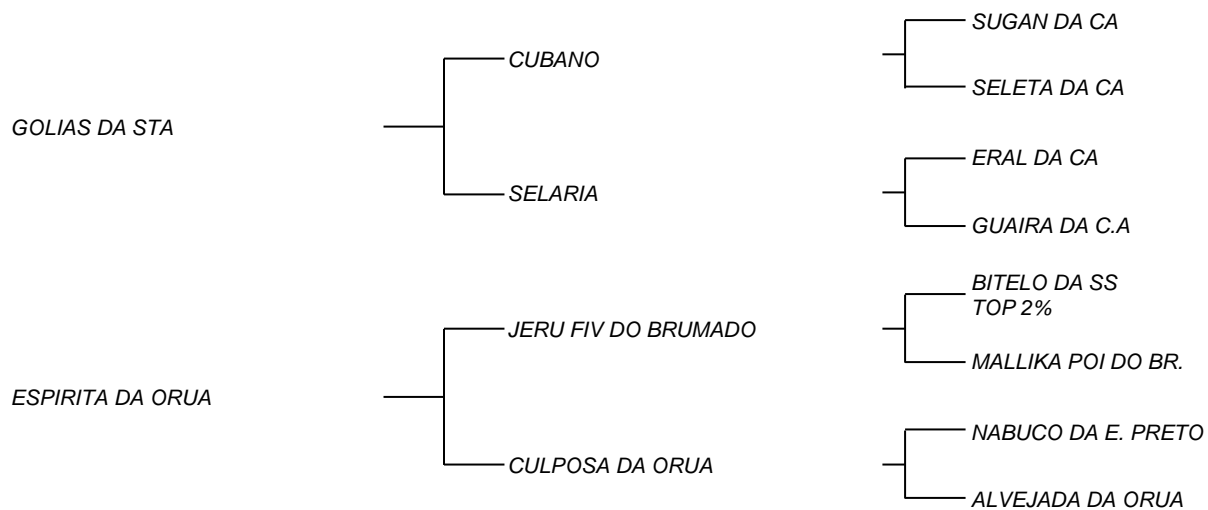

PESO: 595 KG. C.E.: 38,5 CM.



FISIO DA MASSAVI

LOTE: 092

VENDEDOR(ES): AGROPECUARIA SANTA LUCIA

QTD.: 1

FAZENDA: AGROPECUARIA SANTA LUCIA

MSVI 2258 - NELORE - MACHO - NASC.:22/12/2015 - IDADE: 28 MS

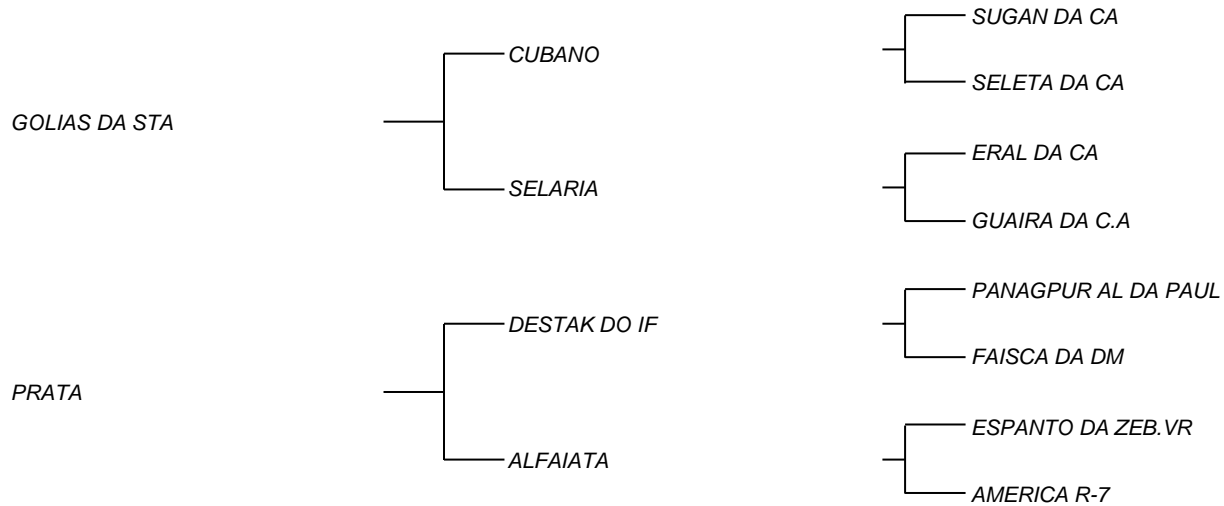

PESO: 601 KG. C.E.: 37,5 CM.

GAIO DA MASSAVI

LOTE: 093

VENDEDOR(ES): AGROPECUARIA SANTA LUCIA

QTD.: 1

FAZENDA: AGROPECUARIA SANTA LUCIA

MSVI 2540 - NELORE - MACHO - NASC.:20/05/2016 - IDADE: 24 MS

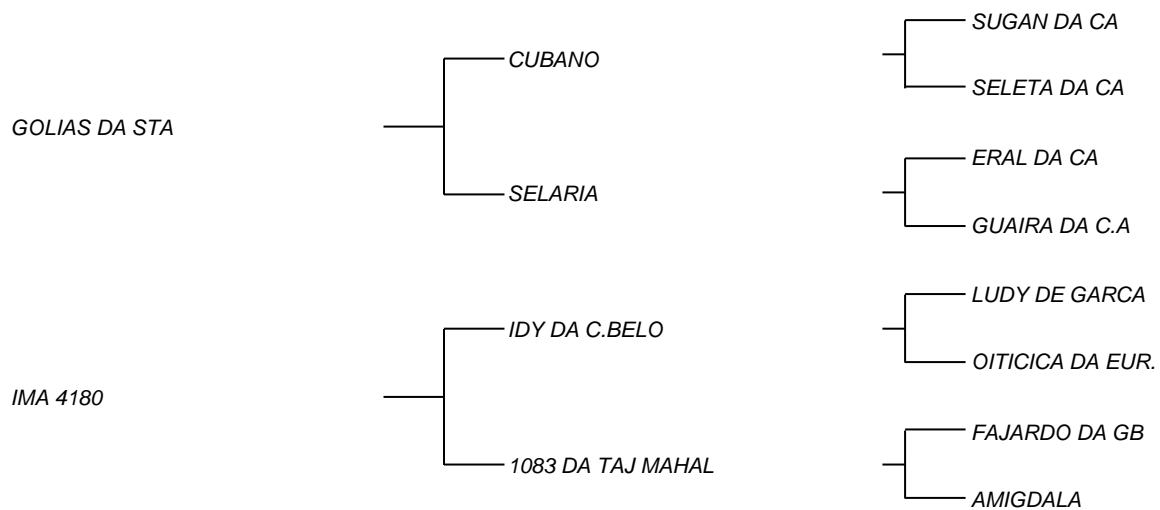

PESO: 480 KG. C.E.: 35 CM.



GENUINO DA MASSAVI

LOTE: 094

VENDEDOR(ES): AGROPECUARIA SANTA LUCIA

QTD.: 1

FAZENDA: AGROPECUARIA SANTA LUCIA

MSVI 2381 - NELORE - MACHO - NASC.:12/02/2016 - IDADE: 27 MS

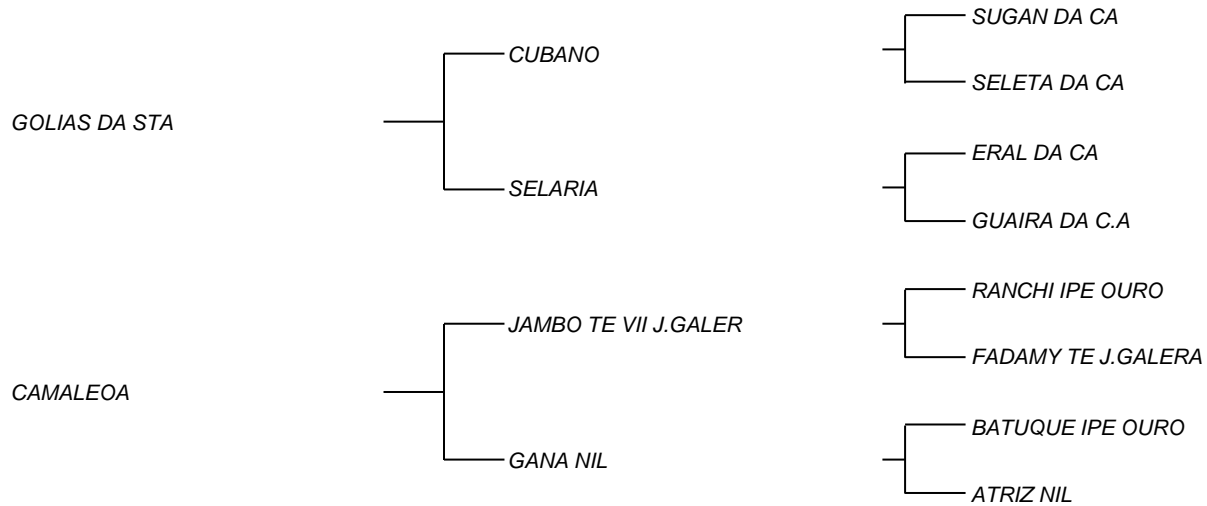

PESO: 550 KG. C.E.: 36 CM.

GINHO DA MASSAVI

LOTE: 095

VENDEDOR(ES): AGROPECUARIA SANTA LUCIA

QTD.: 1

FAZENDA: AGROPECUARIA SANTA LUCIA

MSVI 2415 - NELORE - MACHO - NASC.:16/03/2016 - IDADE: 26 MS

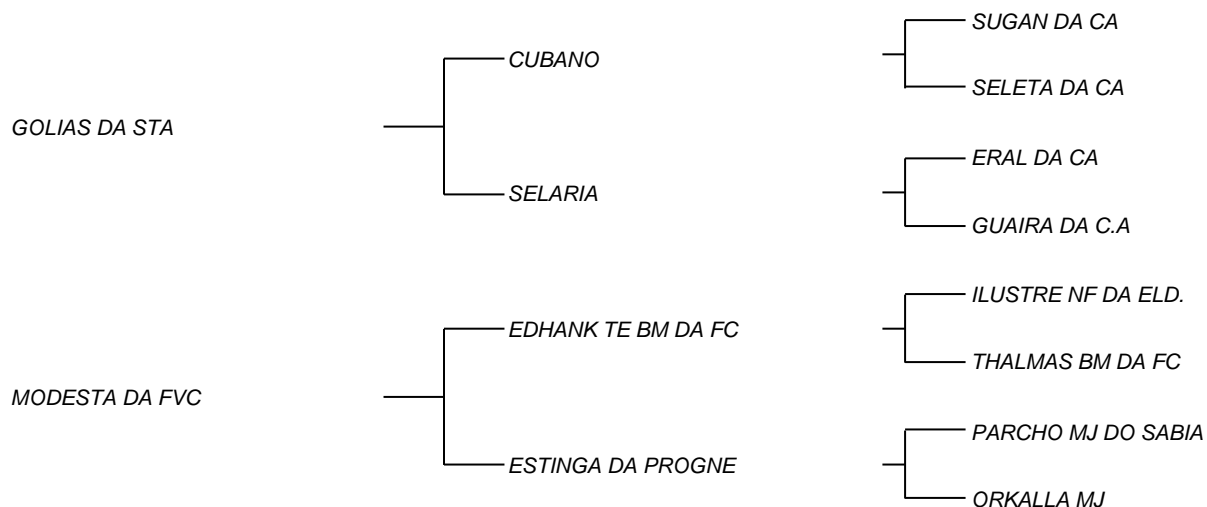

PESO: 600 KG. C.E.: 38 CM.



GALDINO DA MASSAVI

LOTE: 096

VENDEDOR(ES): AGROPECUARIA SANTA LUCIA

QTD.: 1

FAZENDA: AGROPECUARIA SANTA LUCIA

MSVI 2611 - NELORE - MACHO - NASC.:20/08/2016 - IDADE: 20 MS

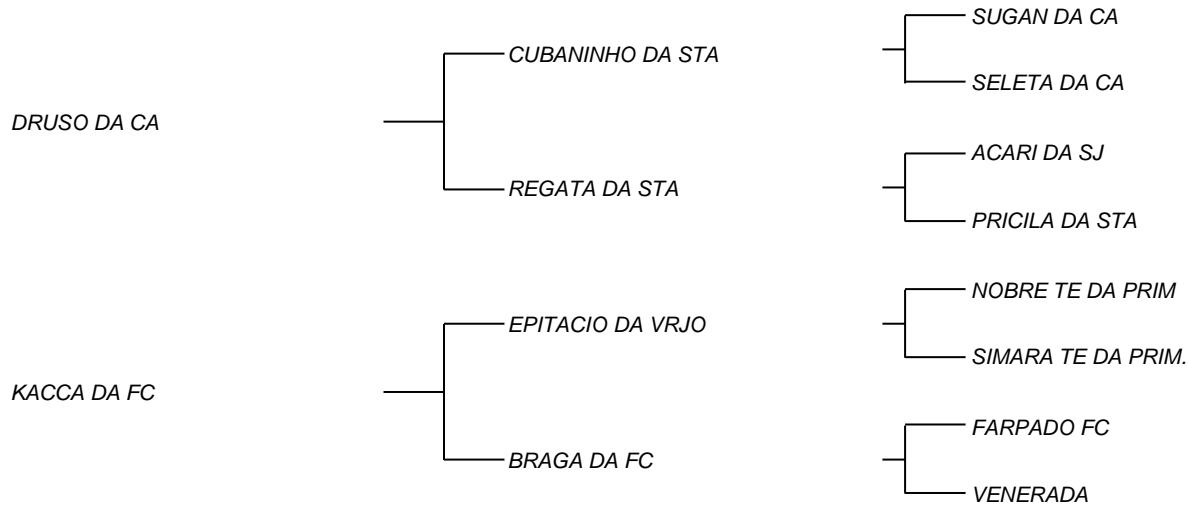

PESO: 482 KG. C.E.: 36 CM.

GEOCENTRICO DA MASSAVI

LOTE: 097

VENDEDOR(ES): AGROPECUARIA SANTA LUCIA

QTD.: 1

FAZENDA: AGROPECUARIA SANTA LUCIA

MSVI 2840 - NELORE - MACHO - NASC.:27/12/2016 - IDADE: 16 MS

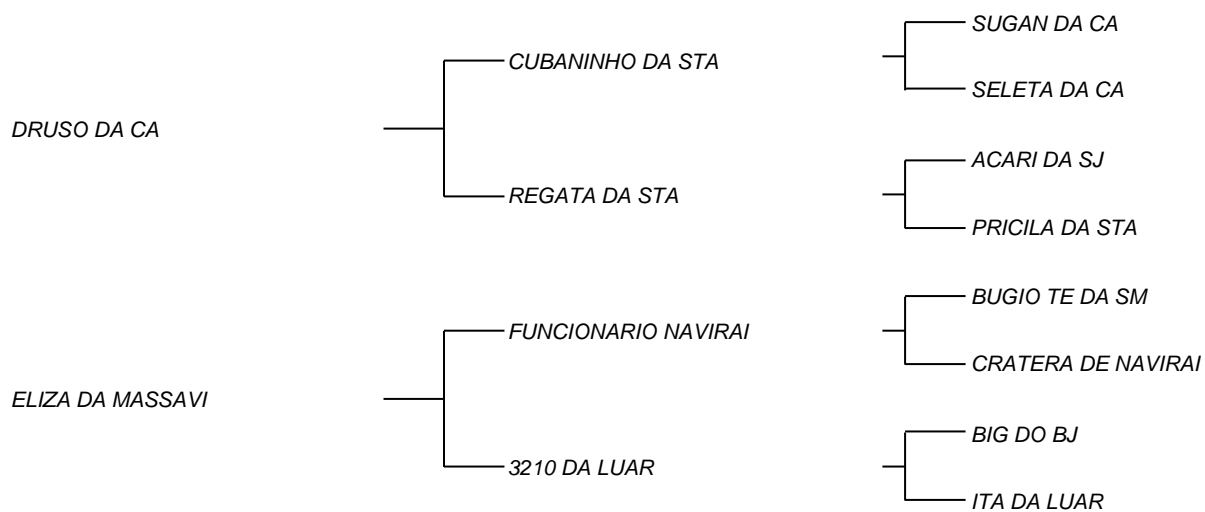

PESO: 408 KG. C.E.: 36 CM.



GALGARDES DA MASSAVI

LOTE: 098

VENDEDOR(ES): AGROPECUARIA SANTA LUCIA

QTD.: 1

FAZENDA: AGROPECUARIA SANTA LUCIA

MSVI 2822 - NELORE - MACHO - NASC.:18/12/2016 - IDADE: 16 MS

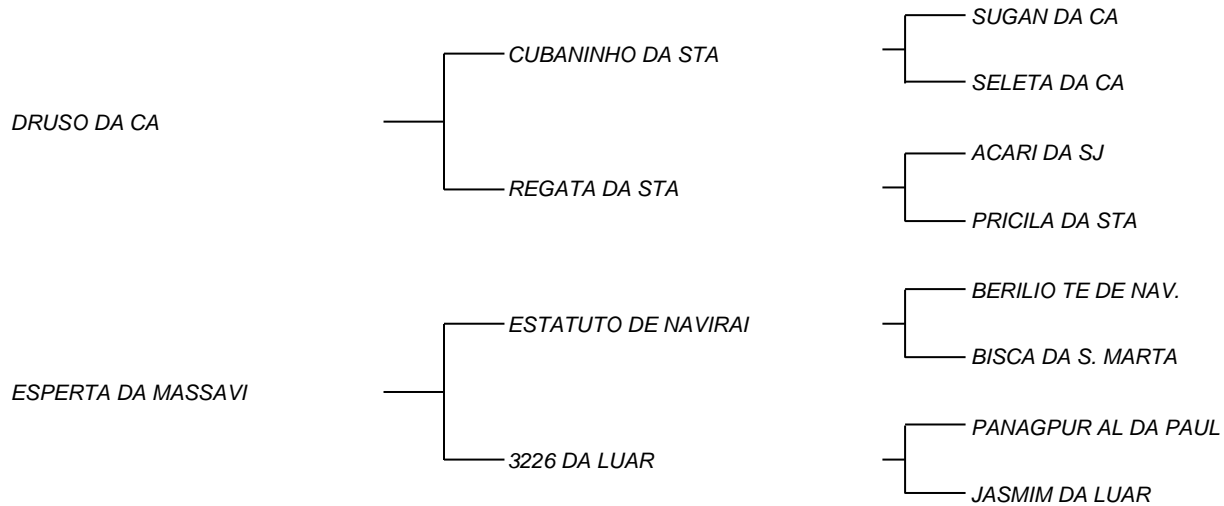

PESO: 380 KG. C.E.: 28 CM.

GASTRO DA MASSAVI

LOTE: 099

VENDEDOR(ES): AGROPECUARIA SANTA LUCIA

QTD.: 1

FAZENDA: AGROPECUARIA SANTA LUCIA

MSVI 2586 - NELORE - MACHO - NASC.:12/08/2016 - IDADE: 21 MS

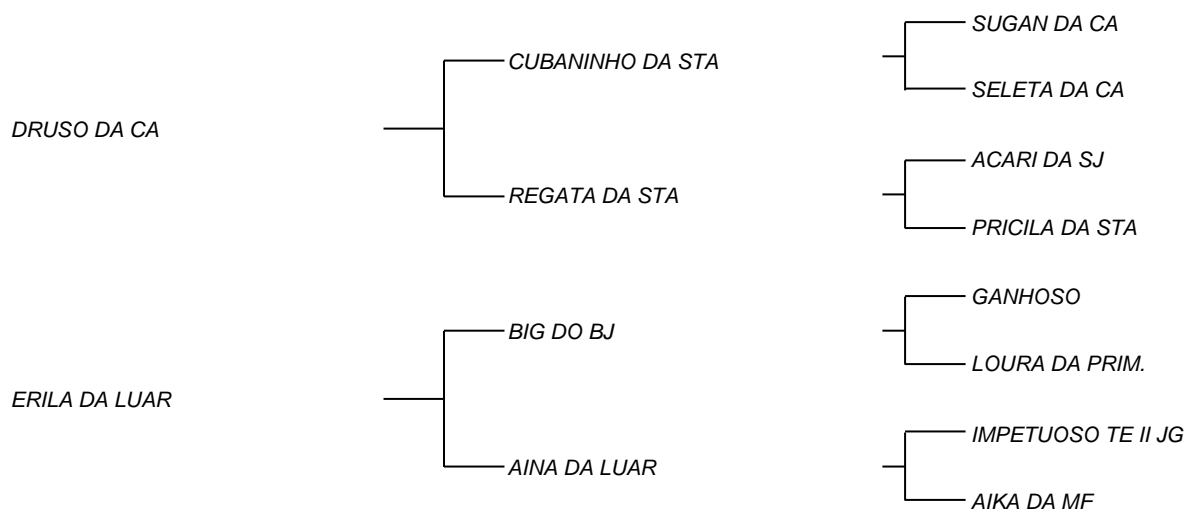

PESO: 530 KG. C.E.: 35 CM.



GETULIO DA MASSAVI

LOTE: 100

VENDEDOR(ES): AGROPECUARIA SANTA LUCIA

QTD.: 1

FAZENDA: AGROPECUARIA SANTA LUCIA

MSVI 2318 - NELORE - MACHO - NASC.:15/01/2016 - IDADE: 27 MS

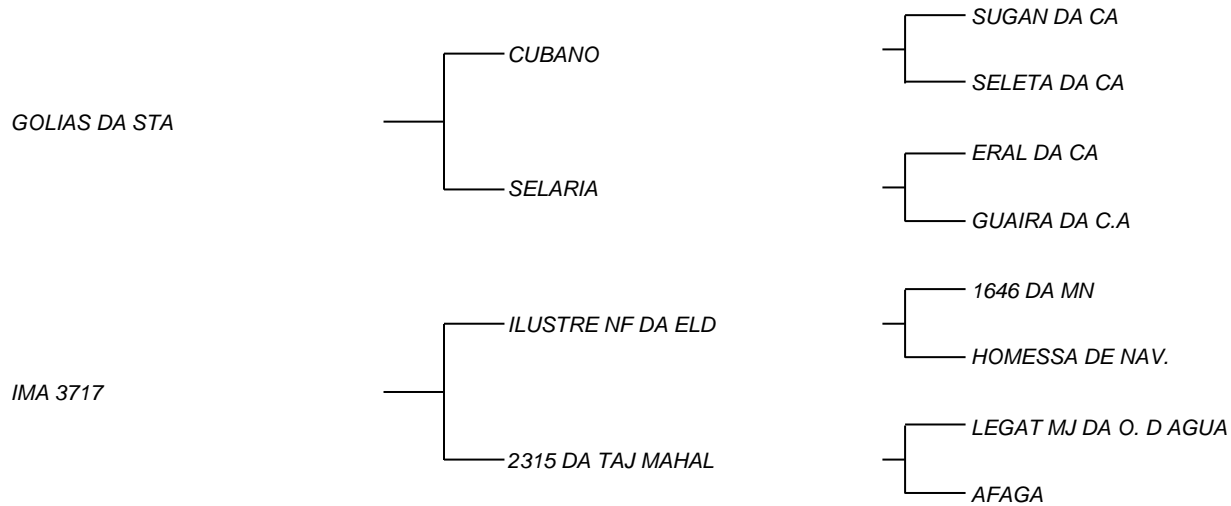

PESO: 656 KG. C.E.: 40 CM.

GARIMPO DA MASSAVI

LOTE: 101

VENDEDOR(ES): AGROPECUARIA SANTA LUCIA

QTD.: 1

FAZENDA: AGROPECUARIA SANTA LUCIA

MSVI 2507 - NELORE - MACHO - NASC.:25/04/2016 - IDADE: 24 MS

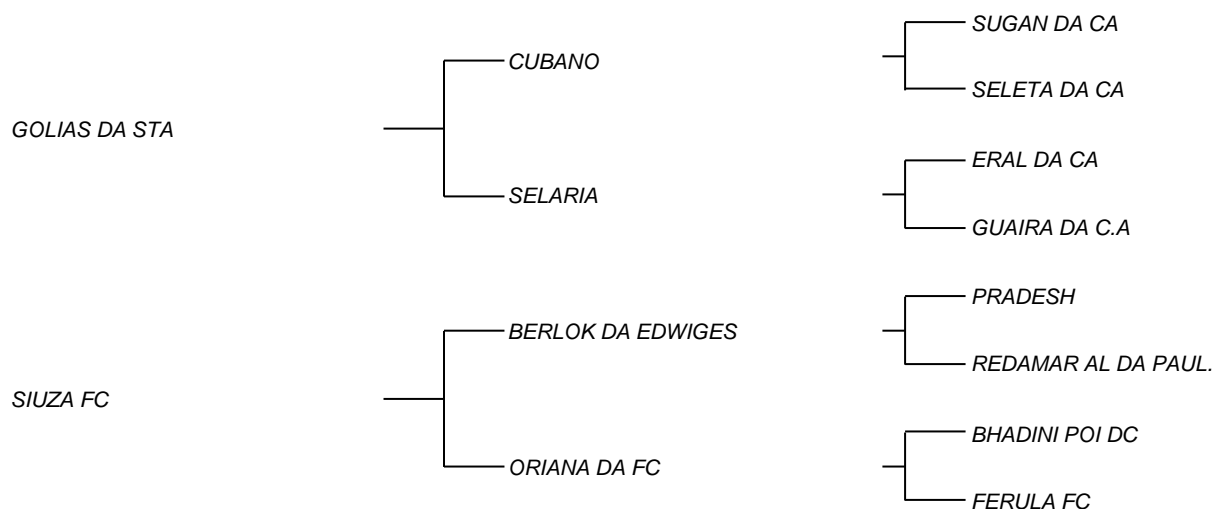

PESO: 591 KG. C.E.: 37,5 CM.



GASTRONOMO DA MASSAVI

LOTE: 102

VENDEDOR(ES): AGROPECUARIA SANTA LUCIA

QTD.: 1

FAZENDA: AGROPECUARIA SANTA LUCIA

MSVI 2583 - NELORE - MACHO - NASC.:10/08/2016 - IDADE: 21 MS

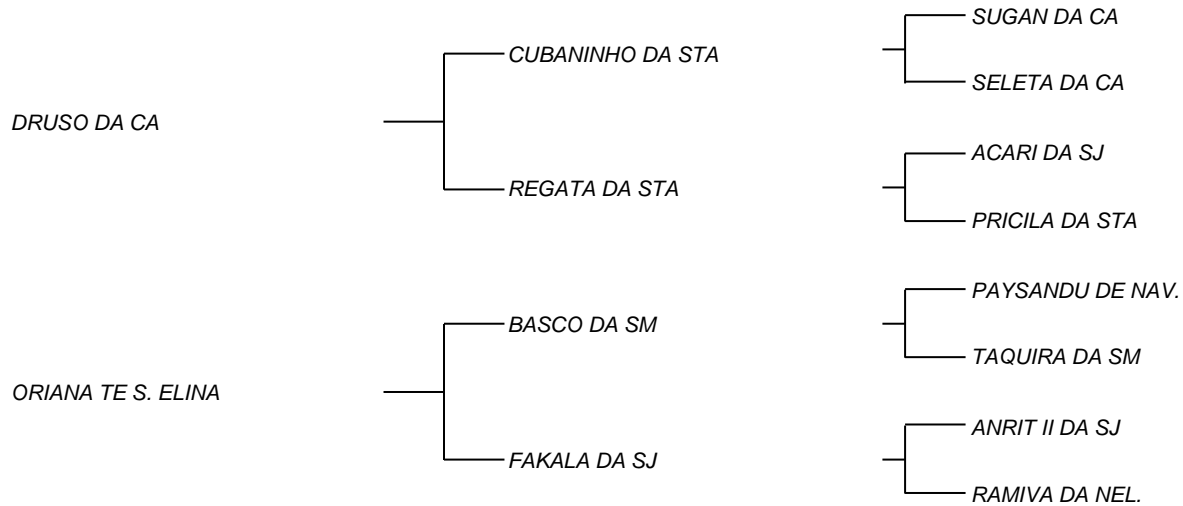

PESO: 512 KG. C.E.: 35 CM.

GOBB DA MASSAVI

LOTE: 103

VENDEDOR(ES): AGROPECUARIA SANTA LUCIA

QTD.: 1

FAZENDA: AGROPECUARIA SANTA LUCIA

MSVI 2652 - NELORE - MACHO - NASC.:21/09/2016 - IDADE: 19 MS

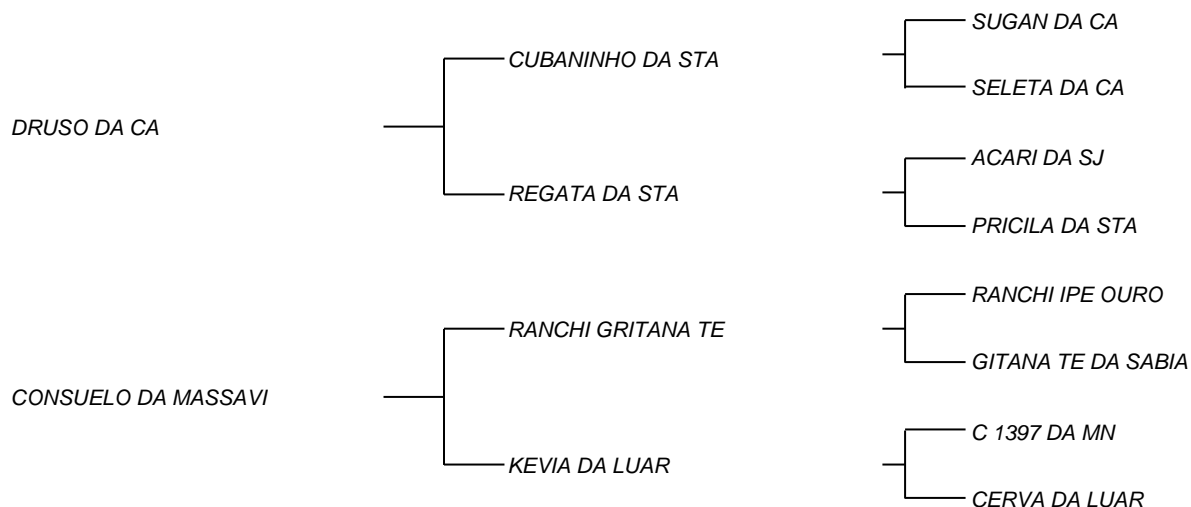

PESO: 488 KG. C.E.: 34 CM.



HABIL DA MASSAVI

LOTE: 104

VENDEDOR(ES): AGROPECUARIA SANTA LUCIA

QTD.: 1

FAZENDA: AGROPECUARIA SANTA LUCIA

MSVI 2849 - NELORE - MACHO - NASC.:03/01/2017 - IDADE: 16 MS

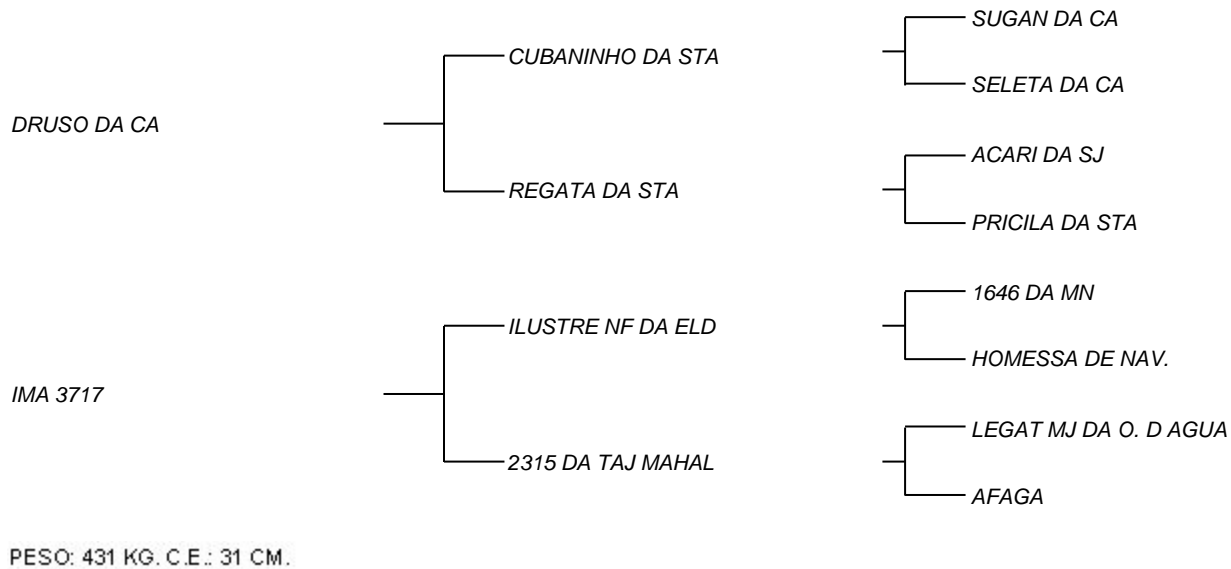

HERBAL DA MASSAVI

LOTE: 105

VENDEDOR(ES): AGROPECUARIA SANTA LUCIA

QTD.: 1

FAZENDA: AGROPECUARIA SANTA LUCIA

MSVI 2860 - NELORE - MACHO - NASC.:03/01/2017 - IDADE: 16 MS

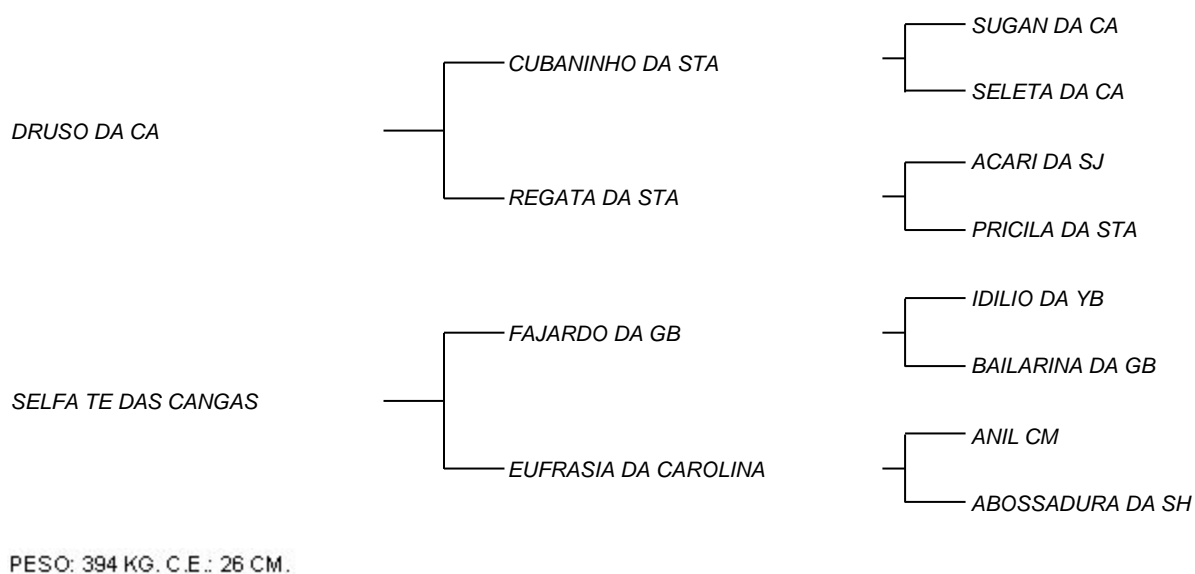



GETTH DA MASSAVI

LOTE: 106

VENDEDOR(ES): AGROPECUARIA SANTA LUCIA

QTD.: 1

FAZENDA: AGROPECUARIA SANTA LUCIA

MSVI 2677 - NELORE - MACHO - NASC.:28/09/2016 - IDADE: 19 MS

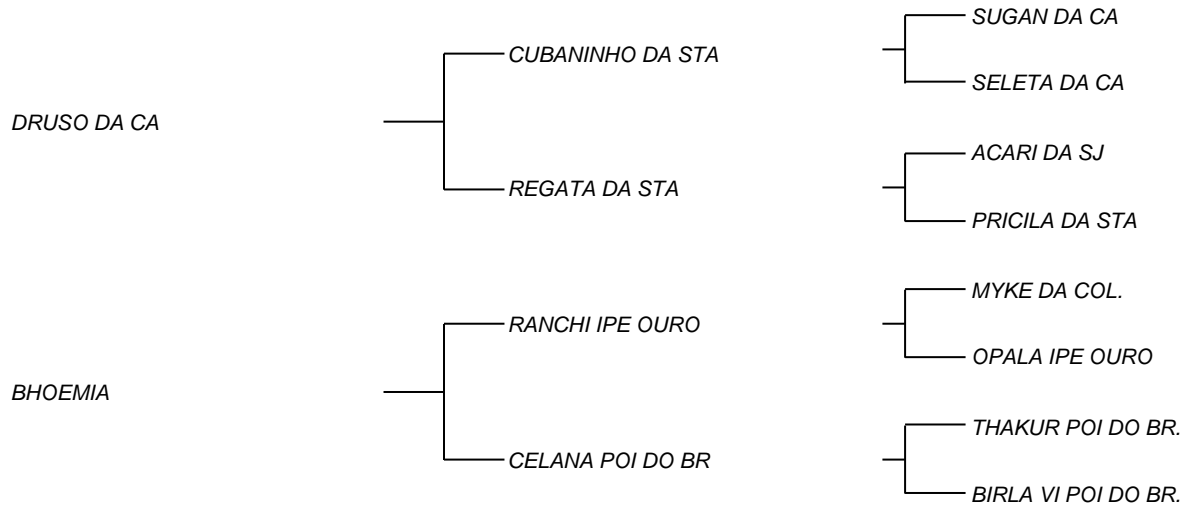

PESO: 463 KG. C.E.: 31 CM.